

Charging Contacts

Enduro⁺ Series Manual

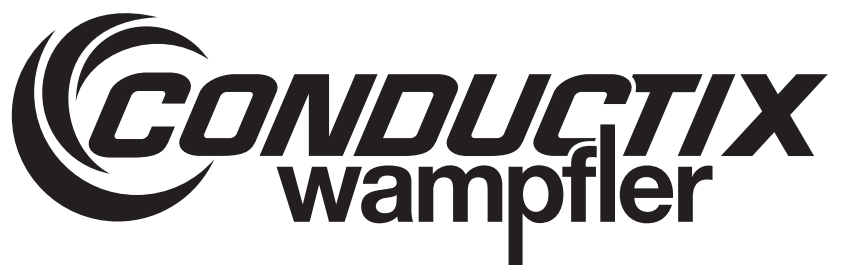
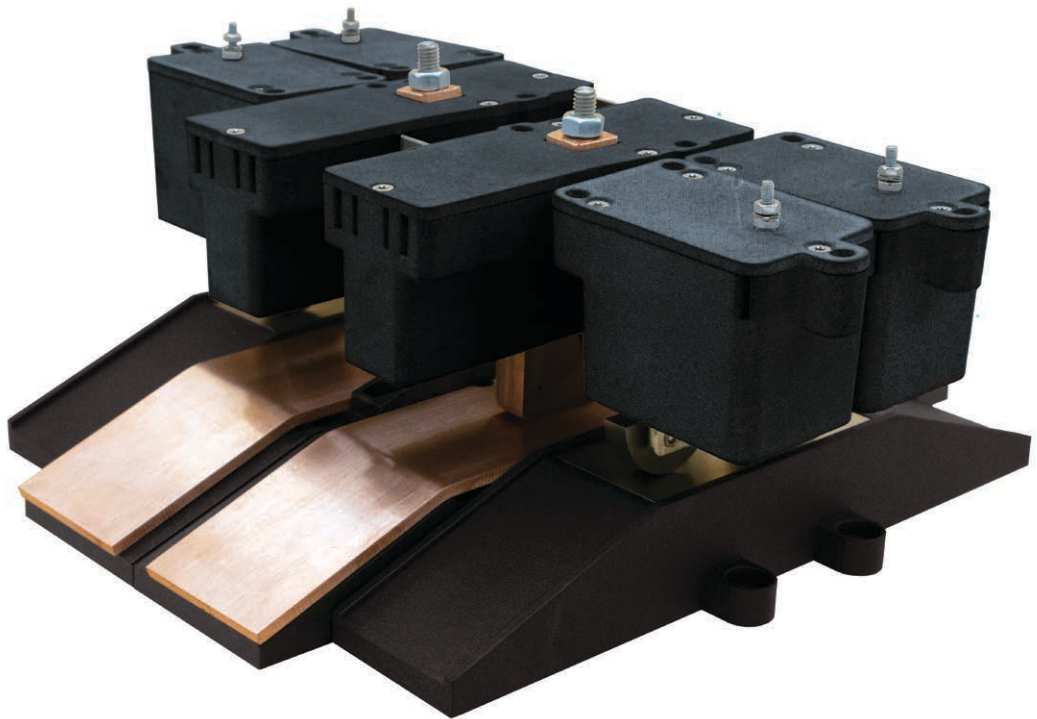

CONDUCTIX INCORPORATED

The technical data and images which appear in this manual are for informational purposes only. **NO WARRANTIES, EXPRESS OR IMPLIED, INCLUDING WARRANTIES OF MERCHANTABILITY OR FITNESS FOR A PARTICULAR PURPOSE, ARE CREATED BY THE DESCRIPTIONS AND DEPICTIONS OF THE PRODUCTS SHOWN IN THIS MANUAL.** Conductix Inc. makes no warranty (and assumes no liability) as to function of equipment or operation of systems built according to customer design or of the ability of any of its products to interface, operate or function with any portions of customer systems not provided by Conductix Inc.

Seller agrees to repair or exchange the goods sold hereunder necessitated by reason of defective workmanship and material discovered and reported to Seller within one year after shipment of such goods to Buyer.

Except where the nature of the defect is such that it is appropriate, in Seller's judgment, to effect repairs on site, Seller's obligation hereunder to remedy defects shall be limited to repairing or replacing (at Seller's option) FOB point of original shipment by Seller, any part returned to Seller at the risk and cost of Buyer. Defective parts replaced by Seller shall become the property of Seller.

Seller shall only be obligated to make such repair or replacement if the goods have been used by Buyer only in service recommended by Seller and altered only as authorized by Seller. Seller is not responsible for defects which arise from improper installation, neglect, or improper use or from normal wear and tear.

Additionally, Seller's obligation shall be limited by the manufacturer's warranty (and is not further warranted by Seller) for all parts procured from others according to published data, specifications or performance information not designed by or for Seller.

Seller further agrees to replace or at Seller's option to provide a refund of the sales price of any goods that do not conform to applicable specifications or which differ from that agreed to be supplied which non-conformity is discovered and forthwith reported to Seller within thirty (30) days after shipment to the Buyer. Seller's obligation to replace or refund the purchase price for non-conforming goods shall arise once Buyer returns such goods FOB point of original shipment by Seller at the risk and cost of Buyer. Goods replaced by Seller shall become the property of Seller.

There is no guarantee or warranty as to anything made or sold by Seller, or any services performed, except as to title and freedom from encumbrances and, except as herein expressly stated and particularly, and without limiting the foregoing, there is no guarantee or warranty, express or implied, of merchantability or of fitness for any particular purpose or against claim of infringement or the like.

Seller makes no warranty (and assumes no liability) as to function of equipment or operation of systems built to Buyer's design or of the ability of any goods to interface, operate or function with any portions of Buyer's system not provided by Seller.

Seller's liability on any claim, whether in contract, tort (including negligence), or otherwise, for any loss or damage arising out of, connected with, or resulting from the manufacture, sale, delivery, resale, repair, replacement or use of any products or services shall in no case exceed the price paid for the product or services or any part thereof which give rise to the claim. In no event shall Seller be liable for consequential, special, incidental or other damages, nor shall Seller be liable in respect of personal injury or damage to property not the subject matter hereof unless attributable to gross misconduct of Seller, which shall mean an act or omission by Seller demonstrating reckless disregard of the foreseeable consequences thereof.

Seller is not responsible for incorrect choice of models or where products are used in excess of their rated and recommended capacities and design functions or under abnormal conditions. Seller assumes no liability for loss of time, damage or injuries to property or persons resulting from the use of Seller's products. Buyer shall hold Seller harmless from all liability, claims, suits and expenses in connection with loss or damage resulting from operation of products or utilization of services, respectively, of Seller and shall defend any suit or action which might arise there from in Buyer's name - provided that Seller shall have the right to elect to defend any such suit or action for the account of Buyer. The foregoing shall be the exclusive remedies of the Buyer and all persons and entities claiming through the Buyer.

CONDUCTIX-WAMPFLER FIELD SERVICE

Need Field Service for our products? We Can Handle It!

Ask us for a quote on expert system installations, inspections, preventative maintenance, and repairs/retrofits.

As the world's largest single source manufacturer of mobile electrification products, Conductix-Wampfler has the unique ability to offer a degree of service not found anywhere else. Conductix-Wampfler's team of highly qualified service technicians and engineers have years of experience servicing our complete line of products.

We can provide:

- **Annual Service contracts**
- **Installation**
- **Commissioning**
- **Installation supervision** to ensure your installers avoid common mistakes.
- **Troubleshooting** to get you up and running.
- **Pre-planned inspections** to complement your preventive maintenance program.

Call 1-800-521-4888 for further details.



TABLE OF CONTENTS

SECTION 1 - SAFETY	5
1.0 Safety Information Responsibility	5
1.1 Safety Messages	5
1.2 Limitation of Liability	5
1.3 Personnel Requirements-Qualifications	6
1.4 Personnel Requirements-Unauthorized Personnel	6
1.5 Personnel Requirements - Training	7
1.6 Personnel Protective Equipment	7
SECTION 2 - PRODUCT DISPOSAL	8
2.0 Product Disposal & Recycling	8
SECTION 3 - SPECIFICATIONS AND WARNINGS	9
3.0 Electrical Warning	9
3.1 Operational Warnings	9
3.2 Maintenance Warnings	9
3.3 Specifications and Listings	9
3.4 Temperature, Voltage, and Ampere Ratings	9
3.5 Product Markings	9
SECTION 4 - INSTALLATION	10-12
4.0 Handling	10
4.1 Application Types	10
4.2 General Assembly Instructions	10
4.3 Mounting of Collector	10
4.4 Mounting for Base	11
4.5 Concrete Floor Mounting	12
SECTION 5 - MAINTENANCE	13
5.0 System Inspections	13
5.1 Brushes	13
5.2 Brush Springs	13
5.3 Electrical Connections	13
SECTION 6 - STORAGE	14
6.0 Packaging	14
6.1 Long-Term Storage	14
SECTION 7 - TROUBLESHOOTING	15
7.0 Troubleshooting	15
SECTION 8 - REPLACEMENT PARTS	15
8.0 Replacement Parts	15

SECTION 1 - SAFETY

1.0 Safety Information Responsibility

1.0.1 All owner, operator, and maintenance personnel must read and understand all manuals associated with this product before installation, operation, or maintenance.

1.0.2 The manual provides information on the recommended installation, operation, and maintenance of this product. Failure to read and follow the information provided could cause harm to yourself or others and/or cause product damage. No one should install, operate, or attempt maintenance of this product prior to familiarizing themselves with the information in this manual.

1.1 Safety Messages

The following safety messages are used in this manual to alert you to specific and important safety related information.

CAUTION

CAUTION indicates unsafe actions or situations that have the potential to cause injury, and/or minor equipment or property damage.

DANGER

DANGER indicates hazards that have the potential to cause severe personal injury or death.

WARNING

WARNING indicates unsafe actions or situations that have the potential to cause severe injury, death, and/or major equipment or property damage.

NOTE

NOTE is used to alert you to installation, operation, programming, or maintenance information that is important, but not hazard related.

1.2 Limitation of Liability

1.2.1 All data and information in this mounting instructions have been compiled in compliance with the applicable standards and regulations, best practice and our many years of experience and knowledge.

1.2.2 The manufacturer accepts no liability for damages resulting from:

- Failure to comply with this document
- Improper use
- Use by untrained personnel
- Unauthorized modifications
- Technical changes
- Use of unauthorized replacement parts and accessories
- The actual scope of delivery may differ from the explanations and descriptions provided here if the model in question is a special one, if additional equipped has been ordered or due to recent technical changes.

1.2.3 The obligations agreed upon in the delivery agreement and our General Terms and Conditions of business apply, as do the delivery conditions of the manufacturer and the legal regulations applicable at the time the contract was concluded.

1.2.4 All products are subject to technical modifications in the context of improvement of function and further development.

SECTION 1 - SAFETY

1.3. Personnel Requirements-Qualifications

WARNING

- **Inadequately trained persons are at risk of injury!**
Improper use can result in serious personal injury or material damage. All activities must only be performed by qualified personnel.

1.3.1 Only persons who can be expected to perform their work reliably are acceptable personnel. People whose reactions are impaired by drugs, alcohol or medications, for example, are not authorized.

1.3.2 When selecting personnel, follow all age- and occupation-specific guidelines applicable at the location of use.

1.3.3 The following qualifications are specified in the operating instructions for certain fields of activity.

1.3.4 Trained personnel and operators

- Will have participated in a training session, given by the owner, on the tasks assigned to them and the potential hazards in case of improper conduct.
- The owner of the machine or system must document that the appropriate training has taken place.

1.3.5 Specialist personnel

- Will consist of persons capable of performing assigned tasks and independently identifying and avoiding potential hazards based on their specialist training, knowledge and experience as well as their knowledge of the applicable regulations. Persons are deemed to be technically qualified if they have successfully completed training as a master electrician, apprentice electrician, electrical engineer or electrical technician. Persons are also considered technically qualified if they have been employed in an appropriate capacity for several years, receiving theoretical and practical training in that line, and their knowledge and skills have been tested by a specialist in the appropriate field of training.
- The machine or system owner must document that the appropriate certificates or other proofs of qualification have been or are being provided.

1.4 Personnel Requirements-Unauthorized Personnel

WARNING

- **Danger due to unauthorized personnel!**
Unauthorized persons who do not meet the requirements described here are not acquainted with the dangers in the working area. Keep unauthorized personnel away from the working area. In case of doubt, address the person and direct them away from the working area. Stop working, as long as unauthorized persons are in the working area.

SECTION 1 - SAFETY

1.5 Personnel Requirements-Training

1.5.1 Before commissioning the equipment, personnel must be trained by the owner. Log the implementation of training for better traceability.

Example of a training log:

Date	Name	Training Type	Training Instructor	Signature
11/5/2019	John Doe	First safety training for personnel	Dave Miller	

1.6 Personal Protective Equipment

1.6.1 For every task, always use:

Safety helmet: For protection against falling or flying parts and materials.

Protective gloves: For the protection of hands against friction, scrapes, puncture or deeper wounds, as well as against contact with hot surfaces.

Protective work clothing: Primarily for protection against entrapment by moving machine parts. Work clothing must be close fitting with a low resistance to tearing; it must have close-fitting sleeves and no protruding parts.

Protective footwear: For protection against heavy falling parts and slipping on slippery floors.

For special tasks, specific protective equipment is required when executing particular tasks:

Safety eye wear: For eye protection against harmful influences such as strong light, chemicals, dust, splinters or weather effects.

Hearing protection: For protection against loud noises and to prevent acoustic trauma.

Breathing mask (FFP-3 - according to country-specific requirements): For protection against materials, particles, and organisms.
In this case, for protection against the dust produced by the abrasion of carbon brushes and the PVC insulation of the conductor rail.

SECTION 2 - PRODUCT DISPOSAL

2.0 Product Disposal and Recycling

2.0.1 Once the product has reached its end of life it must be disassembled and disposed of in accordance with local and regional environmental requirements.

2.0.2 In the absence of a return and disposal agreement, disassembled components must be recycled as follows:

- All metallic parts must be sorted and recycled by material type
- All plastic components must be sorted and recycled by material type
- All other components are to be disposed of in accordance with their material composition. Take care with items identified as Substances of Concern.

2.0.3 Local authorities or special disposal companies can provide information about environmentally appropriate disposal.

SECTION 3 - SPECIFICATIONS AND WARNINGS

3.0 Electrical Warning

3.0.1 Install the charging contact system with the National Electric Code (NEC) or local codes and/or ordinances applicable in your region.

WARNING

- **HAZARD OF ELECTRICAL SHOCK OR BURN!** Always disconnect the power before attempting to perform any service function. Follow lock-out/tag-out procedures as outlined in OSHA section 1910.147 where appropriate.
- Do not use charging contacts with electrical loads greater than the rated current and voltage. Information regarding the current and voltage rating for each contact is recorded on the component type label. Further details can be found in the product catalog.

3.1 Operational Warnings

3.1.1 Means of final installation and integrations of this equipment are the responsibility of the OEM integrator. Modification of this equipment may cause excessive wear or failure and will void the warranty. Modification may cause safety and fire hazards, the end user takes sole responsibility for any modifications made to the product and in doing so absolves Conductix-Wampfler from any liability.

3.2 Maintenance Warnings

3.2.1 Exercise care when installing, servicing, adjusting, and operating the charging contacts and charging system. Periodically check all fasteners and hardware to ensure they are properly tightened. Reference the drawing provided with the product for fastener torque specifications. If you have any questions concerning the use of installation of your product, contact the factory:

- North and South America: +1 800 521 4888
- Europe and Asia: +49 7621 6620

3.3 Specifications and Listings

3.3.1 The charging contact products are built to comply with UL and IEC specifications and standards, but are generally certified or listed by an independent body.

3.3.2 All charging contact products conform, as applicable, to the following standards:

- IEC 60204-1 Electrical equipment of machines-PELV device
- EC 60364-4-42 Protection against thermal effects
- IEC 60644-1 Insulation coordination for equipment within low-voltage systems
- IEC 60999-1 Safety requirements for screw-type and screwless-type clamping units
- IEC 61140 Protection against electric shock-PELV device
- UL 840, UL 746C, UL 583

3.3.3 Please consult factory for details related to CE marking.

3.4 Temperature, Voltage, and Ampere Ratings

3.4.1 Charging contact products are rated to withstand a maximum operating temperature of 120°C (248°F) and minimum operating temperature of -30°C (-22°F). The current and voltage rating of each contact is recorded on the component type label. Further details can be found in the product catalog. Charging contacts can be supplied with a large variety of connections, voltage ratings, and ampere ratings. Consult the factory for additional details.

3.5 Product Markings

3.5.1 Each base plate and vehicle collector is marked with a type label containing the Conductix name and logo, the product catalog number, and the voltage and ampere rating for the product.

SECTION 4 - INSTALLATION

CAUTION

- Charging Contacts should be protected within the end-product application in a separately fused circuit with suitable over-current protection.

4.0 Handling

4.0.1 Do not handle brush and copper parts with bare hands. Always handle the unit by supporting the plastic base plate or collector plate.

4.1 Application Types

4.1.1 Common applications include, but are not limited to, battery or capacitor charging in the following equipment: automatic guided vehicles (AGV), pallet shuttle systems, and material handling systems.

4.1.2 Charging contacts are sold as individual components, base and collector. See **Figure: 4-1** for additional details.

NOTE

- Enclosures are not provided with charging contact assemblies. The OEM integrator must provide an appropriate enclosure that meets applicable safety standards in their region.

4.2 General Assembly Instructions

4.2.1 Torque all fasteners to the specified value(s) indicated on the drawing provided with the product.

NOTE

- Due to the large variety of possible mounting configurations, fasteners for mounting the collector and base plate are not provided with the product.

4.3 Mounting for Collector

1. Mount the collector assembly to allow for overall mounting height as well as maximum collector movement to ensure consistent contact when in use. See **Figure: 4-2**.
2. The collector assembly should be supported around the clearance hole location, out to a minimum diameter of 2 times the clearance hole diameter. See **Figure: 4-3**.

NOTE

- Provisions for making the electrical connections are provided for on the collector assemblies. Reference the provided drawing for brush stud size.
- Care must be taken when connecting the brush to ensure the correct phases are clustered together. Any fault condition resulting from improper installation is the responsibility of the user.

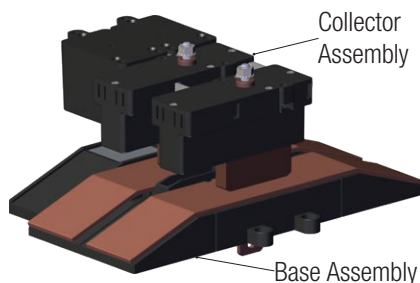

Figure: 4-1

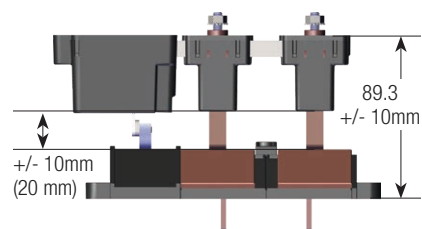

Figure: 4-2

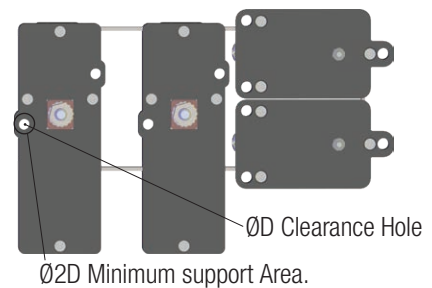

Figure: 4-3

SECTION 4 - INSTALLATION

4.4 Mounting For Base

1. Mount the base plate assembly using the provided clearance holes for socket head cap screws. See **Figure: 4-4**.

NOTE

- Provisions for making electrical connections are provided on the base plate assembly.
 - Care must be taken when connecting the cable lugs to ensure the correct phases are clustered together. Reference the provided drawing for cable lug size. Any fault condition resulting from improper installation is the responsibility of the user.
2. The base plate must be mounted in a suitable enclosure for the service environment.
 3. For 60Vdc (25Vac) service, per UL583 pollution degree 3 a minimum clearance of 3.2 mm and creepage of 6.4 mm must be maintained between each phase, and phase to ground.

NOTE

- This value may vary based on voltage, enclosure type, and regional standards.

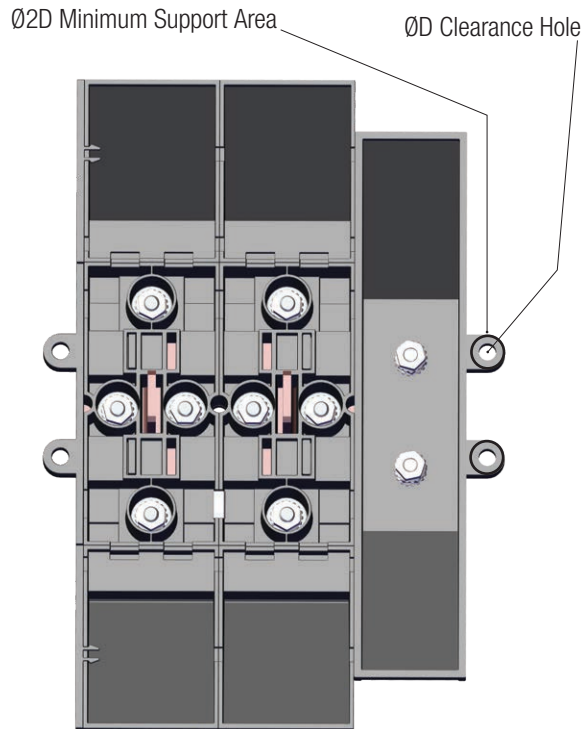

Figure: 4-4

SECTION 4 - INSTALLATION

4.5 Concrete Floor Mounting

4.5.1 Some configurations may require a floor installation.

1. Install AGV-Collectors on vehicle in direction of travel.
2. Install AGV-Base Plate on top of the floor.

NOTE

- Reference the supplied drawing to determine the Target Mounting Distance at Mid-Stroke
 - Allowable Z Tolerance = ± 10 mm
3. Seal around the edge of the base plate using an RTV silicone or foam gasket material.
 4. Set base plates on top of 1 concrete cutout square. See Figure: 4-6.

NOTE

- Concrete cutout size will vary on application
 - The base concrete material must have a minimum thickness of 3.0"
5. Use a ruler or scale and permanent marker to draw the layout of the base plates and mounting holes on the concrete cutout square. See Figure: 4-6.
 6. Drill pilot holes for concrete anchors. Conductix-Wampfler recommends steel drop-in type anchors. See Figure: 4-7.
 7. Be sure to drill depth of anchor only and hammer with set tool when anchor is flush with top of concrete. Follow concrete anchor manufacturer's instructions. See Figure: 4-7.
 8. Set steel drop-in anchors (requires a set tool).
 9. Place bolts in anchors but do not tighten down - this will prevent concrete dust and small pieces from falling in the holes.
 10. Cut the concrete perimeter first and then make small cross cuts. To minimize chisel use, use a diamond concrete cutting wheel. See Figure: 4-8.
 11. Use diamond concrete cutting wheel and chisel to remove large pieces of concrete after cutting. See Figure: 4-8.
 12. Clean the surface of the concrete cutout square of any debris.
 13. Install cables onto base plates.

NOTE

- Concrete cuts may need to be extended to accommodate cabling.
14. Remove bolts and set base plates on concrete cutout square layout.

15. Replace bolts and tighten to manufacturer's torque specification.
16. If desired, fill the open cuts with an appropriate epoxy.

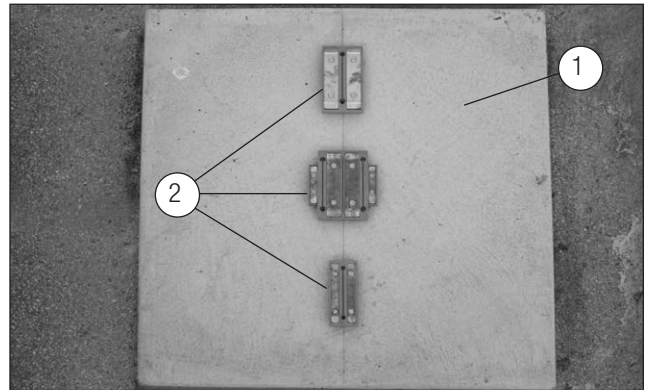

Figure: 2-6

1. Concrete Cutout

2. Base Plates

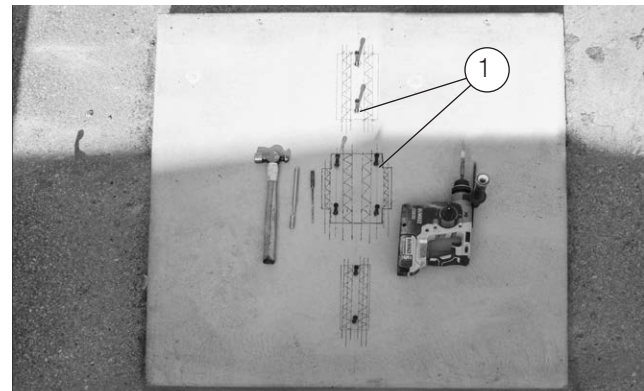

Figure 4-7:

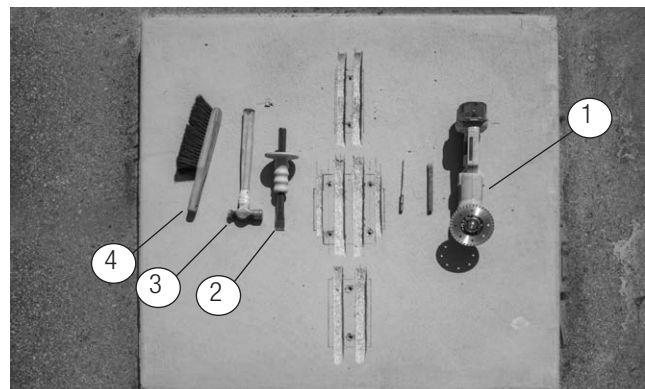

Figure: 4-8

1. Diamond Concrete Cutting Wheel

3. Hammer

2. Chisel

4. Brush

SECTION 5 - MAINTENANCE

WARNING

- Before performing inspections and/or maintenance procedures, ensure all power is disconnected and all safety procedures are followed.

5.0 System Inspections

- 5.0.1 Perform the first inspection after the charging system has cycled 100 times.
- 5.0.2 Ensure that all electrical and mechanical connectors are properly secured, and that the mechanical alignment is within specification. Reference the provided drawing for additional alignment detail.
- 5.0.3 Perform periodic inspections every 15,000-20,000 charging cycles. During these inspections ensure that all electrical and mechanical connectors are properly secured.

5.1 Brushes

- 5.1.1 Inspect the electrical brushes on the collector for wear. If the brush is worn to the wear line etched into the side of the brush, the brush is considered worn and should be replaced. See **Figure: 5-1**.
- 5.1.2 Inspect connection at the brush post to ensure they are still torqued to 5.7 N-m (50 IN-LB) on the power brushes and 1.1 N-m (10 IN-LB) on signal brushes.
- 5.1.3 Inspect the contact surfaces on the base plate for wear.
- 5.1.4 Remove surface dirt, oxidation, pitting, and other contaminants from the contact surfaces via a brass brush or 320 grit sand paper.

CAUTION

- Do not use solvents or chemicals to clean the contact surfaces and/or brushes.

5.2 Brush Springs

- 5.2.1 Inspect and test the brush springs to ensure proper contact pressure. See **Table: 5-1**
- 5.2.2 See **Figure: 5-2** for minimum and maximum lbf values for power and single brushes.

5.3 Electrical Connections

- 5.3.1 Inspect all electrical connections for corrosion.
- 5.3.2 Ensure that all fasteners are properly tightened.

NOTE

- Poor electrical connections can lead to increased electrical resistance and poor charging performance.

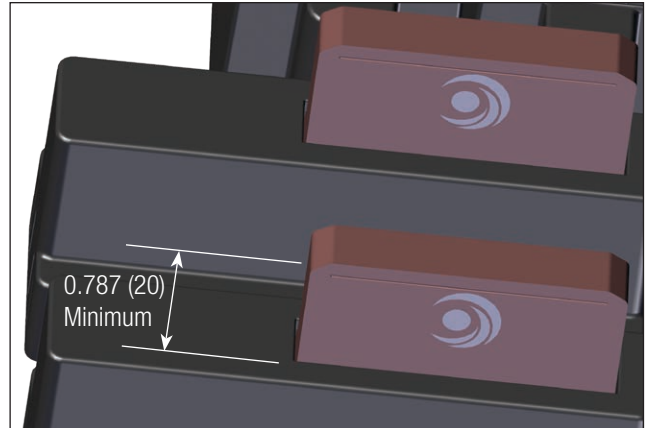

Figure: 5-1

Brush	Min. Force (N/lbs.)	Max. Force (N/lbs)
100A - Single Brush	50.4 N / 11.3 lbs.	91.1 N / 20.5 lbs.
5A (auxiliary) single brush	0.1 N / 0.05 lbs.	7.9 N / 1.8 lbs.
5A (auxiliary) dual brush	0.2 N / 0.10 lbs.	15.7 N / 3.5 lbs.

Table: 5-1

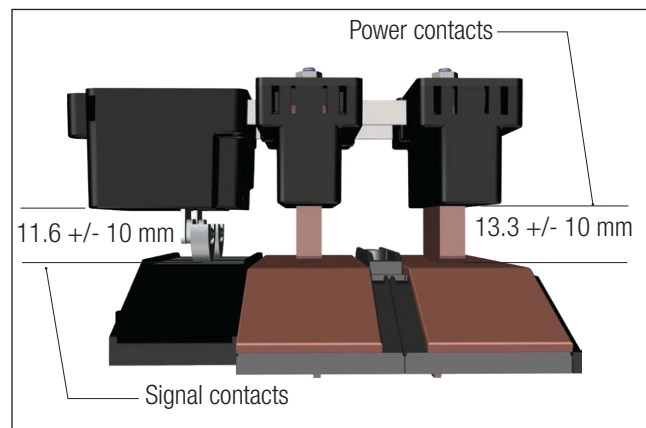

Figure 5-2

SECTION 6 - STORAGE

6.0 Packaging

6.0.1 When storing charging contacts or sub assembly components, care must be taken to ensure the brush contact face and contact face are protected from dirt, debris, abrasion, oils, grease, corrosion.

6.0.2 Plastic bags are recommended to protect the charging contacts or sub assembly components.

6.1 Long-Term Storage

6.1.1 Store charging contacts or components in a dry environment to prevent the formation of corrosion or oxidation on the contact surfaces.

6.1.2 Before use, clean the brush and contact surfaces to remove dirt, oxidation, pitting, and other contaminants via a brass brush or 320 grit sand paper.

SECTION 7 - TROUBLESHOOTING

7.0 Troubleshooting

7.0.1 Potential issues and solutions are shown below in **Table: 7-1**, contact the factory for additional support.

Issue	Potential Cause	Solution
Intermittent charging or loss of charging current	Mechanical Alignment	Inspect the contact sets mechanical alignment, reference the supplied drawing for further details.
	Electrical Connections	Inspect the electrical connections to the base plate and contact brushes
	Brush Contract	Inspect the brush pressure, brush, and contact plate
Damage to brush or contact plate	Mechanical Alignment	Inspect the contact sets mechanical alignment, reference the supplied drawing for further details.

Table: 7-1

SECTION 8 - REPLACEMENT PARTS

8.0 Replacement Parts

8.0.1 We recommend that complete base plates and collectors are replaced when worn for optimal operation. Due to the modular design of charging contacts it is recommended to order the part number that is listed on the original component to be replaced.

www.conductix.us

USA / LATIN AMERICA

10102 F Street
Omaha, NE 68127

Customer Support
Phone +1-800-521-4888

Phone +1-402-339-9300
Fax +1-402-339-9627

info.us@conductix.com
latinamerica@conductix.com

CANADA

1435 Norjohn Court
Unit 5
Burlington, ON L7L 0E6

Customer Support
Phone +1-800-667-2487

Phone +1-450-565-9900
Fax +1-450-951-8591

info.ca@conductix.com

MÉXICO

Calle Treviño 983-C
Zona Centro
Apodaca, NL México 66600

Customer Support
Phone (+52 81) 1090 9519
(+52 81) 1090 9025
(+52 81) 1090 9013

Fax (+52 81) 1090 9014

info.mx@conductix.com

BRAZIL

Rua Dois, 493
Itu, São Paulo, Brasil
CEP: 13312-820

Customer Support
Phone (+55 11) 4813 7330

Fax (+55 11) 4813 7330

info.br@conductix.com

Contact us for our Global Sales Offices

