

# Nexus BB

## Manual

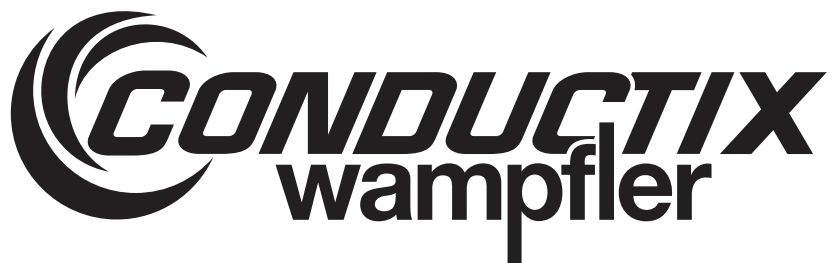

# CONDUCTIX INCORPORATED

The technical data and images which appear in this manual are for informational purposes only. **NO WARRANTIES, EXPRESS OR IMPLIED, INCLUDING WARRANTIES OF MERCHANTABILITY OR FITNESS FOR A PARTICULAR PURPOSE, ARE CREATED BY THE DESCRIPTIONS AND DEPICTIONS OF THE PRODUCTS SHOWN IN THIS MANUAL.** Conductix Inc. makes no warranty (and assumes no liability) as to function of equipment or operation of systems built according to customer design or of the ability of any of its products to interface, operate or function with any portions of customer systems not provided by Conductix Inc.

Seller agrees to repair or exchange the goods sold hereunder necessitated by reason of defective workmanship and material discovered and reported to Seller within one year after shipment of such goods to Buyer.

Except where the nature of the defect is such that it is appropriate, in Seller's judgment, to effect repairs on site, Seller's obligation hereunder to remedy defects shall be limited to repairing or replacing (at Seller's option) FOB point of original shipment by Seller, any part returned to Seller at the risk and cost of Buyer. Defective parts replaced by Seller shall become the property of Seller.

Seller shall only be obligated to make such repair or replacement if the goods have been used by Buyer only in service recommended by Seller and altered only as authorized by Seller. Seller is not responsible for defects which arise from improper installation, neglect, or improper use or from normal wear and tear.

Additionally, Seller's obligation shall be limited by the manufacturer's warranty (and is not further warranted by Seller) for all parts procured from others according to published data, specifications or performance information not designed by or for Seller.

Seller further agrees to replace or at Seller's option to provide a refund of the sales price of any goods that do not conform to applicable specifications or which differ from that agreed to be supplied which non-conformity is discovered and forthwith reported to Seller within thirty (30) days after shipment to the Buyer. Seller's obligation to replace or refund the purchase price for non-conforming goods shall arise once Buyer returns such goods FOB point of original shipment by Seller at the risk and cost of Buyer. Goods replaced by Seller shall become the property of Seller.

There is no guarantee or warranty as to anything made or sold by Seller, or any services performed, except as to title and freedom from encumbrances and, except as herein expressly stated and particularly, and without limiting the foregoing, there is no guarantee or warranty, express or implied, of merchantability or of fitness for any particular purpose or against claim of infringement or the like.

Seller makes no warranty (and assumes no liability) as to function of equipment or operation of systems built to Buyer's design or of the ability of any goods to interface, operate or function with any portions of Buyer's system not provided by Seller.

Seller's liability on any claim, whether in contract, tort (including negligence), or otherwise, for any loss or damage arising out of, connected with, or resulting from the manufacture, sale, delivery, resale, repair, replacement or use of any products or services shall in no case exceed the price paid for the product or services or any part thereof which give rise to the claim. In no event shall Seller be liable for consequential, special, incidental or other damages, nor shall Seller be liable in respect of personal injury or damage to property not the subject matter hereof unless attributable to gross misconduct of Seller, which shall mean an act or omission by Seller demonstrating reckless disregard of the foreseeable consequences thereof.

Seller is not responsible for incorrect choice of models or where products are used in excess of their rated and recommended capacities and design functions or under abnormal conditions. Seller assumes no liability for loss of time, damage or injuries to property or persons resulting from the use of Seller's products. Buyer shall hold Seller harmless from all liability, claims, suits and expenses in connection with loss or damage resulting from operation of products or utilization of services, respectively, of Seller and shall defend any suit or action which might arise there from in Buyer's name - provided that Seller shall have the right to elect to defend any such suit or action for the account of Buyer. The foregoing shall be the exclusive remedies of the Buyer and all persons and entities claiming through the Buyer.

## CONDUCTIX-WAMPFLER FIELD SERVICE

### Need Field Service for our products? We Can Handle It!

Ask us for a quote on expert system installations, inspections, preventative maintenance, and repairs/retrofits.

As the world's largest single source manufacturer of mobile electrification products, Conductix-Wampfler has the unique ability to offer a degree of service not found anywhere else. Conductix-Wampfler's team of highly qualified service technicians and engineers have years of experience servicing our complete line of products.

We can provide:

- **Annual Service contracts**
- **Installation**
- **Commissioning**
- **Installation supervision** to ensure your installers avoid common mistakes.
- **Troubleshooting** to get you up and running.
- **Pre-planned inspections** to complement your preventive maintenance program.

Call 1-800-521-4888 for further details.



# TABLE OF CONTENTS

<b>SECTION 1 - SAFETY</b>	<b>6-8</b>
1.0 Safety Information Responsibility	6
1.1 Safety Messages	6
1.2 Limitation of Liability	6
1.3 Personnel Requirements-Qualifications	7
1.4 Personnel Requirements-Unauthorized Personnel	7
1.5 Personnel Requirements - Training	8
1.6 Personnel Protective Equipment	8
<b>SECTION 2 - PRODUCT DISPOSAL</b>	<b>9</b>
2.0 Product Disposal & Recycling	9
<b>SECTION 3 - INSTALLATION</b>	<b>10-12</b>
3.0 Intended Use	10
3.1 Improper Use	10
3.2 Protective Measures to be Taken by Owner/Operator	11-12
3.3 Emergency Stop	12
3.4 In The Event of Accidents/Malfunctions	12
<b>SECTION 4 - OVERVIEW</b>	<b>13-16</b>
4.0 Nexus BB Modems	13-14
4.1 Nexus BB Modem Filters	15
4.2 Nexus BB Modem Filters Parts List	16
<b>SECTION 5 - SYSTEM WIRING/CONNECTIONS</b>	<b>17-21</b>
5.0 Connection-AC	17
5.1 Connection-DC	18
5.2 Connection-AC (Conductor Bar)	19-20
5.3 Connection-DC (Conductor Bar)	21
<b>SECTION 6 - INSTALLATION</b>	<b>22-33</b>
6.0 Required Tools	22
6.1 Application Examples	22
6.2 Installation Overview	22-23
6.3 Electromagnetic Compatibility (EMC)	23
6.4 Noise Coupling	23
6.5 Distances between cables with different classes	24
6.6 Installation Recommendations	25
6.7 Multiple Nexus BB Systems (domains)	26-27
6.8 EMC/EMI Installation Requirements	27-29
6.9 Equipment Operation	29
6.10 Installation (AC/DC)	29
6.11 Three-Phase Power Connection-Stationary Control Panel	30
6.12 Three-Phase Power Connection-Mobile Control Panel	30
6.13 Single-Phase (120 to 250 VAC/100 to 250 VDC) Power Connection -Stationary Power Control	30
6.14 Single -Phase (120 to 250 VAC/100 to 250 VDC) Power Connection-Mobile Control Panel	31
6.15 Single-Phase (24-48 VDC Modem) Power Connection-Stationary Control Panel	31
6.16 Single-Phase (24-48 VDC Modem) Power Connection - Mobile Control Panel	31
6.17 Termination Wiring	32
6.18 Clearance for Cooling/Wiring	33

# TABLE OF CONTENTS

<b>7.0 MODEM SPECIFICATIONS</b>	<b>34-36</b>
7.0 Maintenance Warnings	34
7.1 System Specifications	34-36
<b>8.0 TROUBLESHOOTING</b>	<b>37</b>

# SECTION 1 - SAFETY

## 1.0 Safety Information Responsibility

- 1.0.1 All owner, operator, and maintenance personnel must read and understand all manuals associated with this product before installation, operation, or maintenance.
- 1.0.2 The manual provides information on the recommended installation, operation, and maintenance of this product. Failure to read and follow the information provided could cause harm to yourself or others and/or cause product damage. No one should install, operate, or attempt maintenance of this product prior to familiarizing themselves with the information in this manual.

## 1.1 Safety Messages

The following safety messages are used in this manual to alert you to specific and important safety related information.

### CAUTION

**CAUTION** indicates unsafe actions or situations that have the potential to cause injury, and/or minor equipment or property damage.

### DANGER

**DANGER** indicates hazards that have the potential to cause severe personal injury or death.

### WARNING

**WARNING** indicates unsafe actions or situations that have the potential to cause severe injury, death, and/or major equipment or property damage.

## NOTE

**NOTE** is used to alert you to installation, operation, programming, or maintenance information that is important, but not hazard related.

## 1.2 Limitation of Liability

- 1.2.1 All data and information in this mounting instructions have been compiled in compliance with the applicable standards and regulations, best practice and our many years of experience and knowledge.
- 1.2.2 The manufacturer accepts no liability for damages resulting from:
- Failure to comply with this document
  - Improper use
  - Use by untrained personnel
  - Unauthorized modifications
  - Technical changes
  - Use of unauthorized replacement parts and accessories
  - The actual scope of delivery may differ from the explanations and descriptions provided here if the model in question is a special one, if additional equipment has been ordered or due to recent technical changes.
- 1.2.3 The obligations agreed upon in the delivery agreement and our General Terms and Conditions of business apply, as do the delivery conditions of the manufacturer and the legal regulations applicable at the time the contract was concluded.
- 1.2.4 All products are subject to technical modifications in the context of improvement of function and further development.

## SECTION 1 - SAFETY

### 1.3. Personnel Requirements-Qualifications

#### **WARNING**

Inadequately trained persons are at risk of injury!

Improper use can result in serious personal injury or material damage. All activities must only be performed by qualified personnel.

1.3.1 Only persons who can be expected to perform their work reliably are acceptable personnel. People whose reactions are impaired by drugs, alcohol or medications, for example, are not authorized.

1.3.2 When selecting personnel, follow all age- and occupation-specific guidelines applicable at the location of use.

1.3.3 The following qualifications are specified in the operating instructions for certain fields of activity.

#### 1.3.4 Trained personnel and operators

- Will have participated in a training session, given by the owner, on the tasks assigned to them and the potential hazards in case of improper conduct.
- The owner of the machine or system must document that the appropriate training has taken place.

#### 1.3.5 Specialist personnel

- Will consist of persons capable of performing assigned tasks and independently identifying and avoiding potential hazards based on their specialist training, knowledge and experience as well as their knowledge of the applicable regulations. Persons are deemed to be technically qualified if they have successfully completed training as a master electrician, apprentice electrician, electrical engineer or electrical technician. Persons are also considered technically qualified if they have been employed in an appropriate capacity for several years, receiving theoretical and practical training in that line, and their knowledge and skills have been tested by a specialist in the appropriate field of training.
- The machine or system owner must document that the appropriate certificates or other proofs of qualification have been or are being provided.

### 1.4 Personnel Requirements-Unauthorized Personnel

#### **WARNING**

Danger due to unauthorized personnel!

Unauthorized persons who do not meet the requirements described here are not acquainted with the dangers in the working area. Keep unauthorized personnel away from the working area. In case of doubt, address the person and direct them away from the working area. Stop working, as long as unauthorized persons are in the working area.

# SECTION 1 - SAFETY

## 1.5 Personnel Requirements-Training

1.5.1 Before commissioning the equipment, personnel must be trained by the owner. Log the implementation of training for better traceability.

Example of a training log:

Date	Name	Training Type	Training Instructor	Signature
11/5/2019	John Doe	First safety training for personnel	Dave Miller	

## 1.6 Personal Protective Equipment

1.6.1 For every task, always use:

**Safety helmet:** For protection against falling or flying parts and materials.

**Protective gloves:** For the protection of hands against friction, scrapes, puncture or deeper wounds, as well as against contact with hot surfaces.

**Protective work clothing:** Primarily for protection against entrapment by moving machine parts. Work clothing must be close fitting with a low resistance to tearing; it must have close-fitting sleeves and no protruding parts.

**Protective footwear:** For protection against heavy falling parts and slipping on slippery floors.

For special tasks, specific protective equipment is required when executing particular tasks:

**Safety eye wear:** For eye protection against harmful influences such as strong light, chemicals, dust, splinters or weather effects.

**Hearing protection:** For protection against loud noises and to prevent acoustic trauma.

**Breathing mask (FFP-3 - according to country-specific requirements):** For protection against materials, particles, and organisms. In this case, for protection against the dust produced by the abrasion of carbon brushes and the PVC insulation of the conductor rail.



## SECTION 2 - PRODUCT DISPOSAL

### 2.0 Product Disposal and Recycling

2.0.1 Once the product has reached its end of life it must be disassembled and disposed of in accordance with local and regional environmental requirements.

2.0.2 In the absence of a return and disposal agreement, disassembled components must be recycled as follows:

- All metallic parts must be sorted and recycled by material type
- All plastic components must be sorted and recycled by material type
- All other components are to be disposed of in accordance with their material composition. Take care with items identified as Substances of Concern.

2.0.3 Local authorities or special disposal companies can provide information about environmentally appropriate disposal.

### CAUTION

#### **Environmental damage due to improper disposal!**

Electrical waste, electronic components, lubricants, and other auxiliary materials are subject to hazardous-waste disposal regulations and may only be disposed of by authorized specialists!

Local authorities or specialist disposal companies can provide information about environmentally appropriate disposal.

## SECTION 3 - USAGE

### 3.0 Intended Use

3.0.1 The data transmission system is designed and built exclusively for the usage described here (intended use).

### WARNING

#### Hazard due to improper use!

- Any application that deviates from or goes beyond the intended use of the devices can result in hazardous situations.
- Strict compliance with the specifications of this manual is required.
- Refrain from improper use of the system.
- Respect the instructions in the following section on improper use.
- The Nexus BB data transmission system is used for data communication between a stationary modem and a mobile modem.

#### Compliance with these technical conditions is mandatory for the installation:

- The maximum permitted traversing speed of the mobile device is 10 m/s.

#### Electrical operating conditions:

- The electrical system must be protected in accordance with local regulations and guidelines.

### 3.1 Improper Use

3.1.0 Claims of any kind due to damage incurred during use that deviates from the intended use described above (“use other than the intended use”) are excluded. The owner bears sole liability for any damage resulting from improper use.

3.1.1 Improper use in particular includes the following forms of use:

- Operation that does not comply with the specified operating conditions.
- Use where there is risk of explosion (“ex” classified zones).
- Use of the system on a conductor not approved by Conductix-Wampfler.
- Use of the system with accessories that are not approved and not authorized by the manufacturer.
- Use of the system by untrained personnel.

## SECTION 3 - USAGE

### 3.2 Protective Measures To Be Taken by Owner/Operator

3.2.0 The data transmission system is used in industrial power distribution networks only. The owner of the data transmission system is therefore subject to the legal obligations concerning workplace safety. In addition to the safety instructions in this document, all safety, accident prevention and environmental regulations that apply where the data transmission system is used must also be observed. In particular, pay attention to the following:

- All electrical connections must be made by trained and skilled personnel.
- Work on electrical components of the system may only be carried out when disconnected from the power supply.
- The owner must become acquainted with the applicable occupational safety regulations and perform a risk analysis to identify additional hazards arising from the specific working conditions where the system is used. This knowledge must be implemented in the form of operating instructions for the data transmission system.
- For the entire time that the data transmission system is in use, the owner must check whether the operating instructions it has produced correspond to the current regulatory situation and adjust them if necessary.
- The owner must clearly regulate and define responsibilities for installation, operation, troubleshooting and maintenance.
- The owner must ensure that all employees involved with the system have read and understood this installation manual. The owner must also train the personnel at regular intervals and inform them of hazards.
- The owner must provide personnel with the necessary protective equipment.
- Owner must keep keys for switching cabinets in a safe place. "Safe" means only explicitly authorized personnel have access to the keys. The keys are only issued to specialist personnel as described in the Personnel Requirements-Qualifications section.
- The owner must verify that the operating frequency of the data transmission system is permitted in the place of use.
- The owner must observe the following standards, regulations and directives when operating the system (see following page):

EMC Directive 2014/53/EU "Radio Equipment" and The US Code of Federal Regulation, Title 47, FCC Part 15B Class A Using Harmonized Product Standards (EN 301 489-1 V2.1.1, EN 55032, EN 55035 and ANSI C63.4)	EMC Description
EN 55032: FCC Part 15.109/ICES-003 Class A using ANSI C63.4	Radiated emissions, 30MHz - 1GHz
EN 55032: FCC Part 15.107/ICES-003 Class A using ANSI C63.4	Conducted emissions, AC Mains and Telecom 150kHz – 30MHz
EN 61000-3-2	Current frequency harmonics
EN 61000-3-3	Voltage fluctuations and flicker
IEC 61000-4-2	Electrostatic discharge, ±4kV contact, ±8 kV air discharge
IEC 61000-4-3	Radiated immunity, 3 V/m, 80MHz - 1GHz, 3 V/m; 1.4GHz - 2.0GHz; 1 V/m: 2.0GHz - 2.7GHz
IEC 61000-4-4	EFT - AC Mains, ±1kV
IEC 61000-4-5	Surge - AC Mains. ±1kV L-L, ±2kV L-PE
IEC 61000-4-6	Conducted immunity - AC Mains, 3 Vrms
IEC 61000-4-11	Immunity dips and interrupts
Electrical Safety to Directive 2014/35/EU "Low Voltage Directive"	
EN 62368-1	Audio/video, information and communication technology equipment - Part 1: Safety requirements
UL and cUL	
UL 61010-1	Safety Requirements for electrical equipment for measurement, control, and laboratory use
CSA C22.2 NO. 61010-1-12	Safety Requirements for electrical equipment for measurement, control, and laboratory use

## SECTION 3 - USAGE

3.2.1 The owner is also responsible for ensuring that the data transmission system is always in perfect working order. Therefore the following applies:

- The operator must ensure that the service intervals described in this document are observed.
- The owner must have all safety systems inspected for functionality and completeness on a regular basis (once yearly if possible, but at least as often as required by applicable national regulations).
- If components or the system have been modified, the safety systems must be re-inspected and adapted to the changed circumstances such that the system is safe again.

### 3.3 Emergency Stop

3.3.0 The Nexus BB data transmission system is used for transparent transmission of safety-relevant signals. These signals must be generated by a higher-level component. Suitable safety components must be used to guarantee the emergency-stop function. The emergency stop must be implemented using safety equipment provided by the customer and depends on the nature of the power supply.

### 3.4 In The Event of Accidents/Malfunctions

3.4.0 Shut down the system and secure it against unauthorized, unintentional and/or erroneous activation. Secure the danger zone and remove all personnel from the danger zone.

- Initiate first-aid measures.
- Alert the rescue services.
- Inform responsible parties at the operating site.
- Clear access routes for emergency vehicles.

3.4.1 In the event of a malfunction:

- Shut down the system and secure it against unauthorized, unintentional and/or erroneous reactivation.
- Secure the work area against entry.
- Consult qualified personnel when analyzing the fault.
- Involve authorized personnel for maintenance and repair.
- Check for disconnection from power.
- Remove the component and replace with a new component.
- Determine the cause of the fault and repair the component.

## SECTION 4 - OVERVIEW

### 4.0 Nexus BB Modems

4.0.0 Nexus BB uses the Powerline Networking technology to send Ethernet data through electrified physical layers (i.e. conductor bar, cable reel, festoon, slip ring) to turn them into a data transmission network. The data transfer is realized between the Nexus BB modems located on the front end of the physical layer.

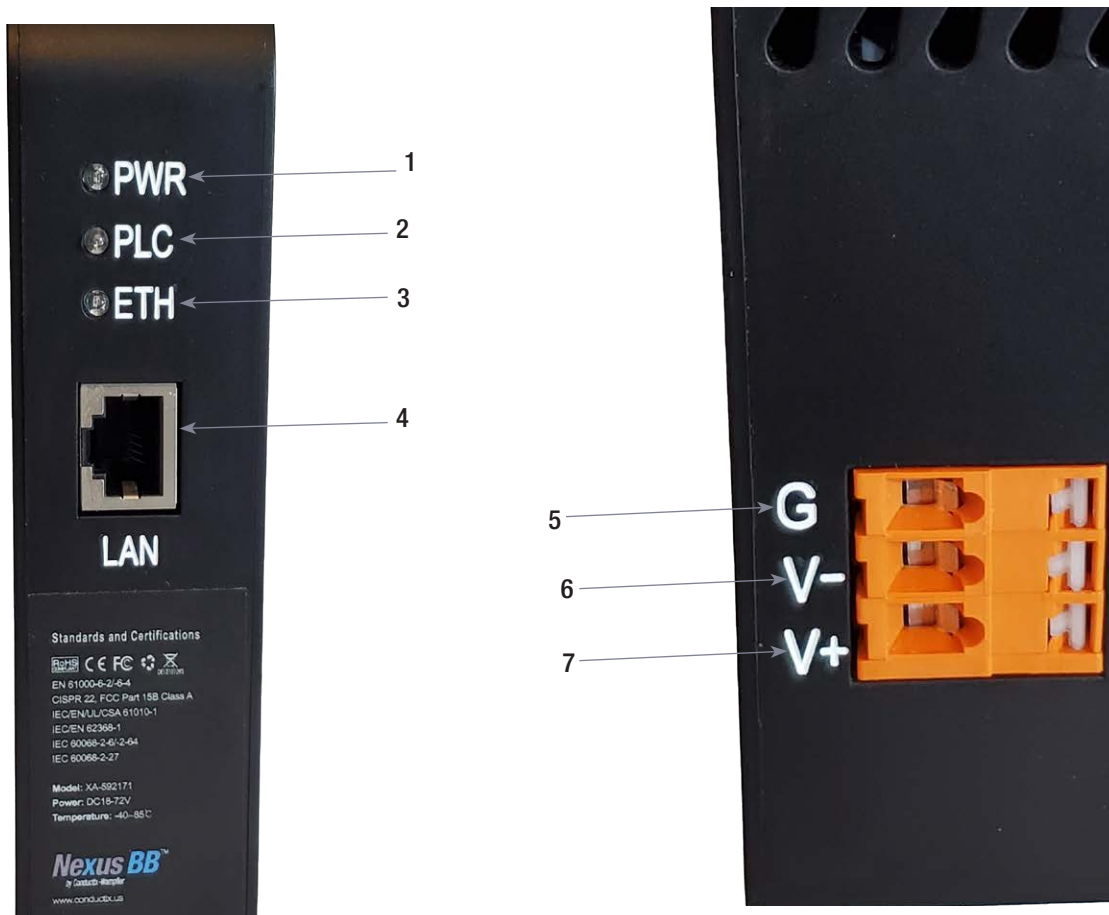

Figure 4-1: Nexus BB (DC modem)

- |   |                       |
|---|-----------------------|
| 1. Power indicator                          | 5. Ground             |
| 2. PLC (Power Line Communication) Indicator | 6. Power supply (DC-) |
| 3. Ethernet indicator                       | 7. Power supply (DC+) |
| 4. Ethernet port                            |                       |

#### Light Description

- Power: On-power on; Off-power off
- PLC: On - successful connection to another modem; Off-unsuccessful connection to another modem. Flashing-receiving/transmitting data.
- Ethernet: On-successful connection to network, Off-unsuccessful connection to network. Flashing - receiving/transmitting Ethernet data.

## SECTION 4 - OVERVIEW

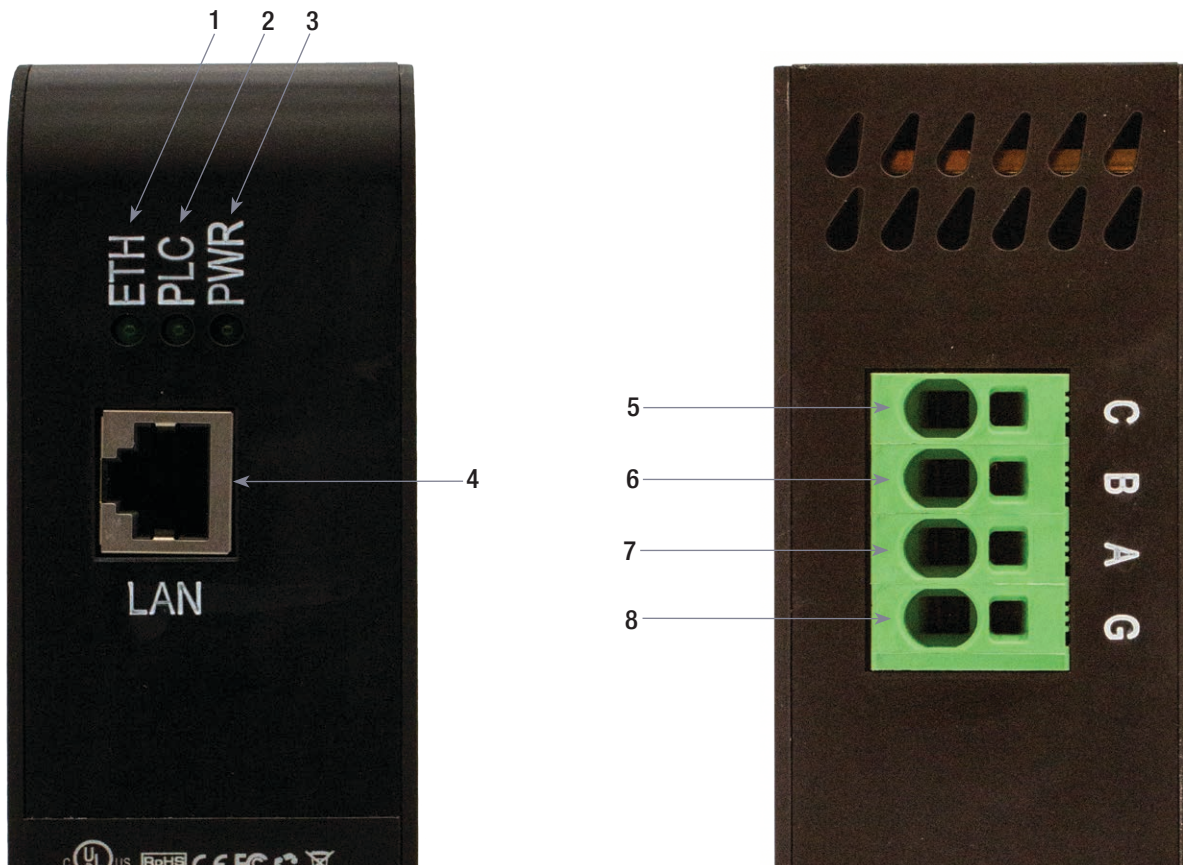

Figure 4-2: Nexus BB (AC modem)

1. Power indicator
2. PLC (Power Line Communication) Indicator
3. Ethernet indicator
4. Ethernet port
5. Power supply (L1-3 $\phi$  or Neutral-1 $\phi$ )
6. Power supply (L2-3 $\phi$  or Line-1 $\phi$ )
7. Power supply (L3-3 $\phi$ )
8. Ground

### Light Description

- Power: On-power on; Off-power off
- PLC: On - successful connection to another modem; Off-unsuccessful connection to another modem.  
Flashing-receiving/transmitting data.
- Ethernet: On-successful connection to network, Off-unsuccessful connection to network.  
Flashing - receiving/transmitting Ethernet data.

# SECTION 4 - OVERVIEW

## 4.1 Nexus BB Modem Filters

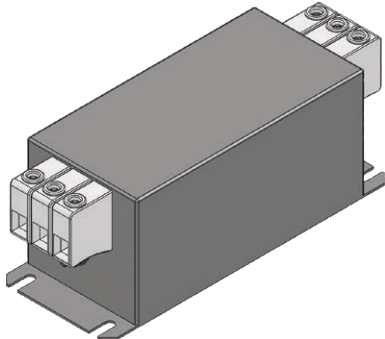

Figure: 4-3

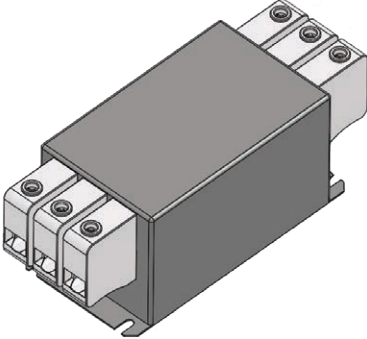

Figure: 4-4

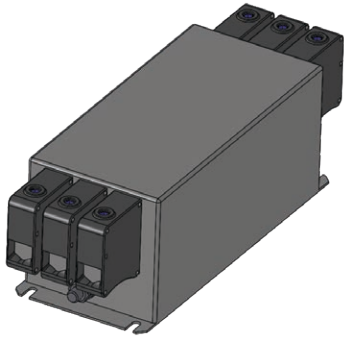

Figure: 4-5

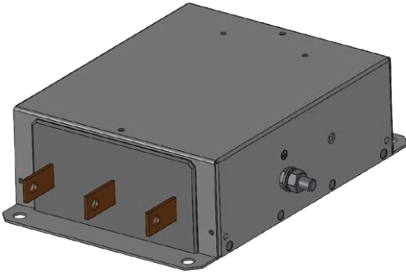

Figure: 4-6

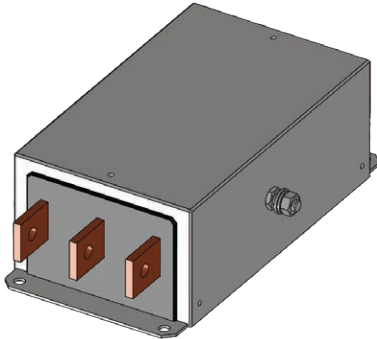

Figure: 4-7

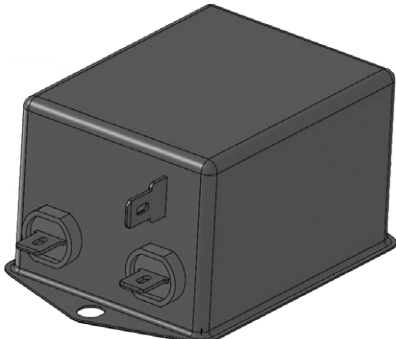

Figure: 4-8

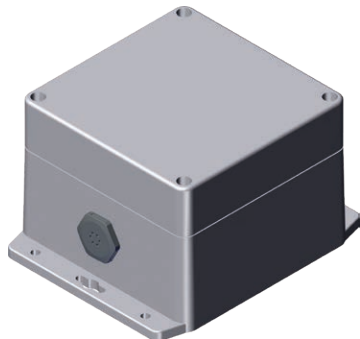

Figure: 4-9

## SECTION 4 - OVERVIEW

### 4.2 Nexus BB Modem Filters Parts List

Figure	Part No.	Description	Length in. (mm)	Width in. (mm)	Height in. (mm)	# of phases	Weight lb. (kg)
4-3	XA-592533	Filter EMC/RFI Nexus BB 10A with hardware	6.45 (163.83)	2.28 (57.91)	2.28 (57.91)	3	0.88 (0.40)
4-3	XA-592534	Filter EMC/RFI Nexus BB 20A with hardware	6.45 (163.83)	2.28 (57.91)	2.28 (57.91)	3	1.1 (0.50)
4-4	XA-592535	Filter EMC/RFI Nexus BB 50A with hardware	8.54 (216.92)	3.35 (85.09)	3.15 (80.01)	3	2.65 (1.20)
4-5	XA-592336	Filter EMC/RFI Nexus BB 80A with hardware	11.43 (290.32)	3.74 (95)	3.54 (89.92)	3	4.85 (2.20)
4-5	XA-592540	Filter EMC/RFI Nexus BB 100A with hardware	11.43 (290.32)	3.74 (95)	3.54 (89.92)	3	5.73 (2.60)
4-6	XA-592098	Filter EMC/RFI Nexus BB 150A w/ cover	12.6 (320.04)	8.96 (227.58)	3.39 (86.11)	3	13.45 (6.10)
4-6	XA-592099	Filter EMC/RFI Nexus BB 200A w/ cover	12.6 (320.04)	8.96 (227.58)	3.39 (86.11)	3	13.45 (6.10)
4-6	XA-592100	Filter EMC/RFI Nexus BB 600A w/ cover	12.6 (320.04)	8.92 (226.57)	3.39 (86.11)	3	16.98 (7.70)
4-7	XA-592103	Filter EMC/RFI Nexus BB 1000A w/ cover	16.14 (409.96)	8.62 (218.95)	4.92 (124.97)	3	34.83 (15.80)
4-8	XA-592554	Filter AC/DC EMI Nexus BB 20A with hardware	3.49 (88.65)	2.13 (54.10)	1.59	1	0.63 (0.28)
4-9	*Terminator	Terminating resistor- Nexus BB	5.91 (150.11)	4.81 (122.17)	3.54 89.92	1 or 3	0.91 (.41)

#### NOTE:

\*For DC applications other Single Phase Filters are available, please contact factory

\*Terminating resistor part number varies on selected bar system



# SECTION 5 - SYSTEM WIRING/CONNECTIONS

## NOTE:

- The wiring diagrams shown in Section 5 are recommended; however, all local and regional electrical codes shall be adhered to. All fuses shown in Section 5 are for protection of wiring providing power to the Nexus BB modem and the fuse size is dependent upon the wiring size (20A maximum).

## 5.0 Connection-AC

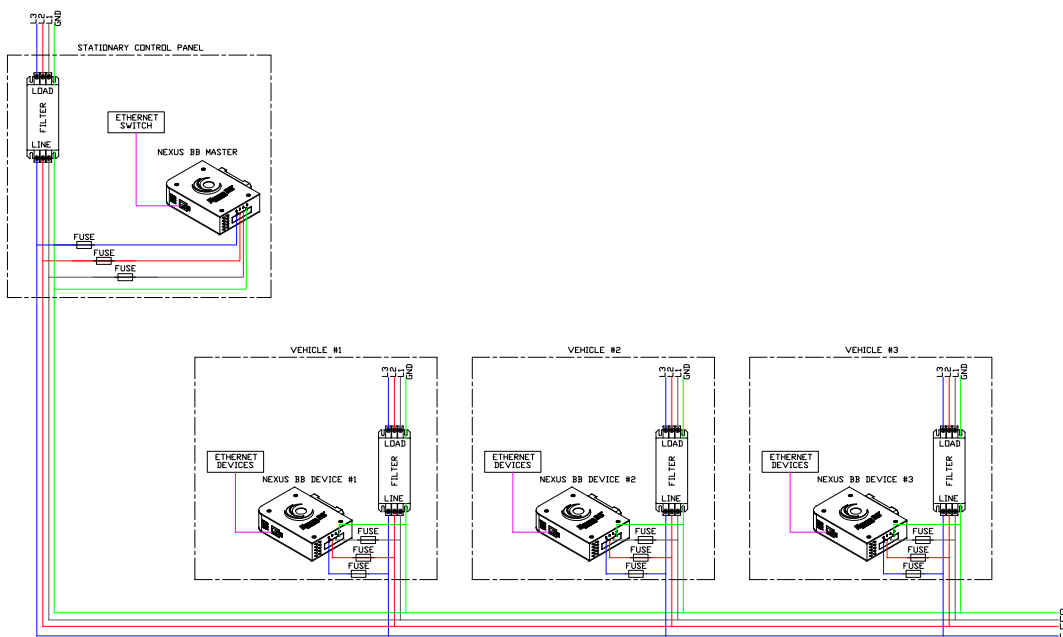

Figure 5-1: Three-Phase AC modem

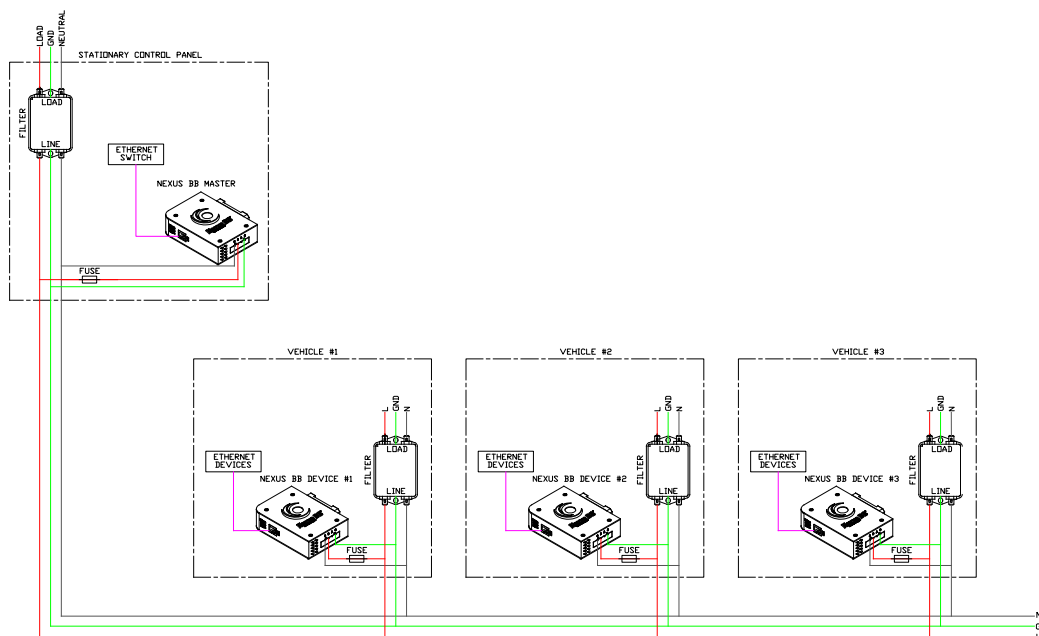

Figure 5-2: Single-Phase AC modem

# SECTION 5 - SYSTEM WIRING/CONNECTIONS

## 5.1 Connection-DC

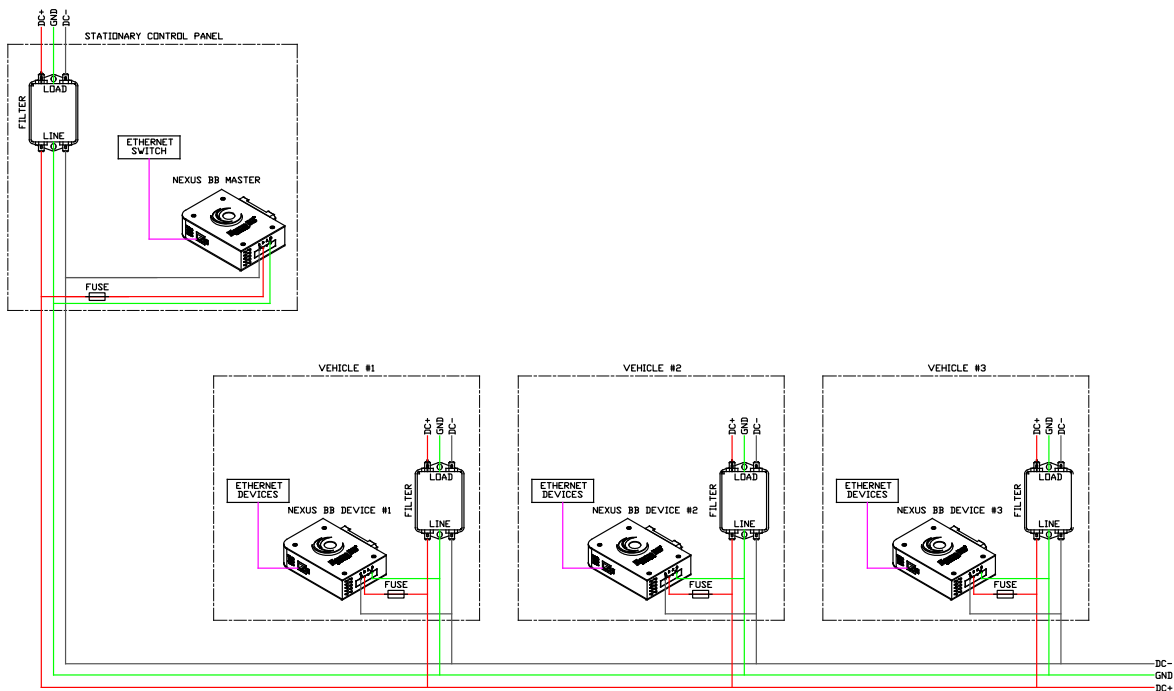

Figure 5-3: High-Voltage DC modem

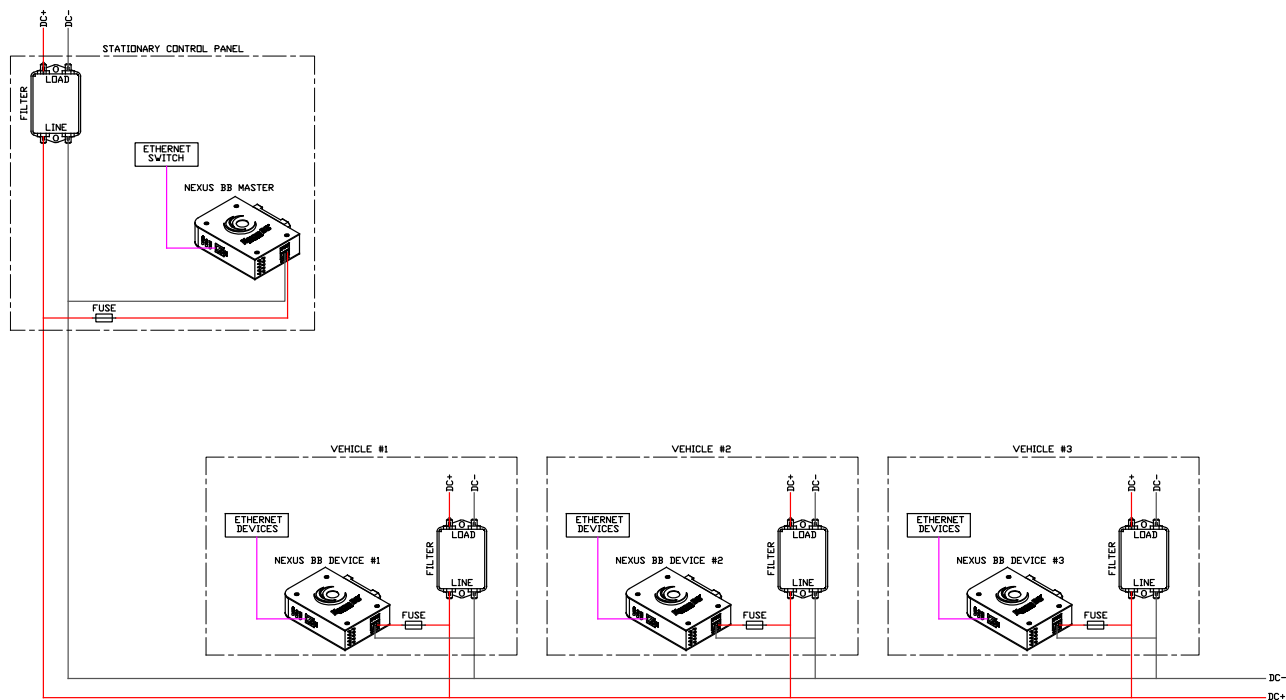

Figure 5-4: 48V DC modem

# SECTION 5 - SYSTEM WIRING/CONNECTIONS

## 5.2 Connection - AC (Conductor Bar)

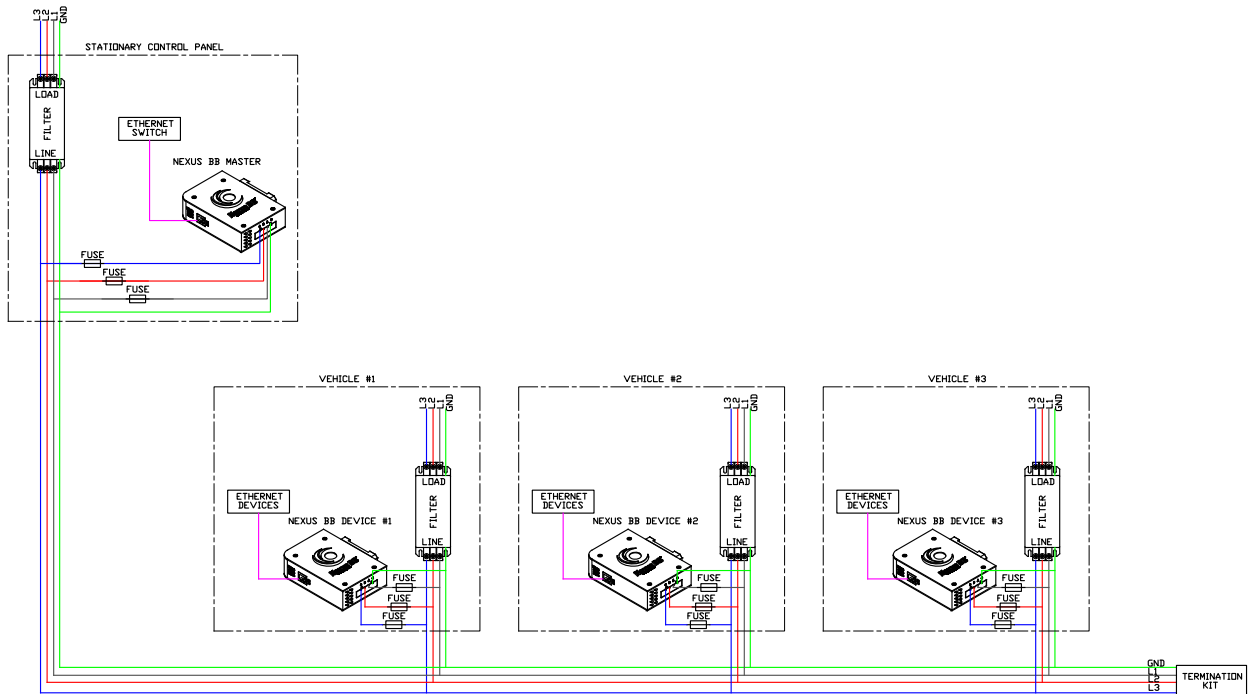

Figure 5-5: Three-Phase AC modem conductor bar (end feed)

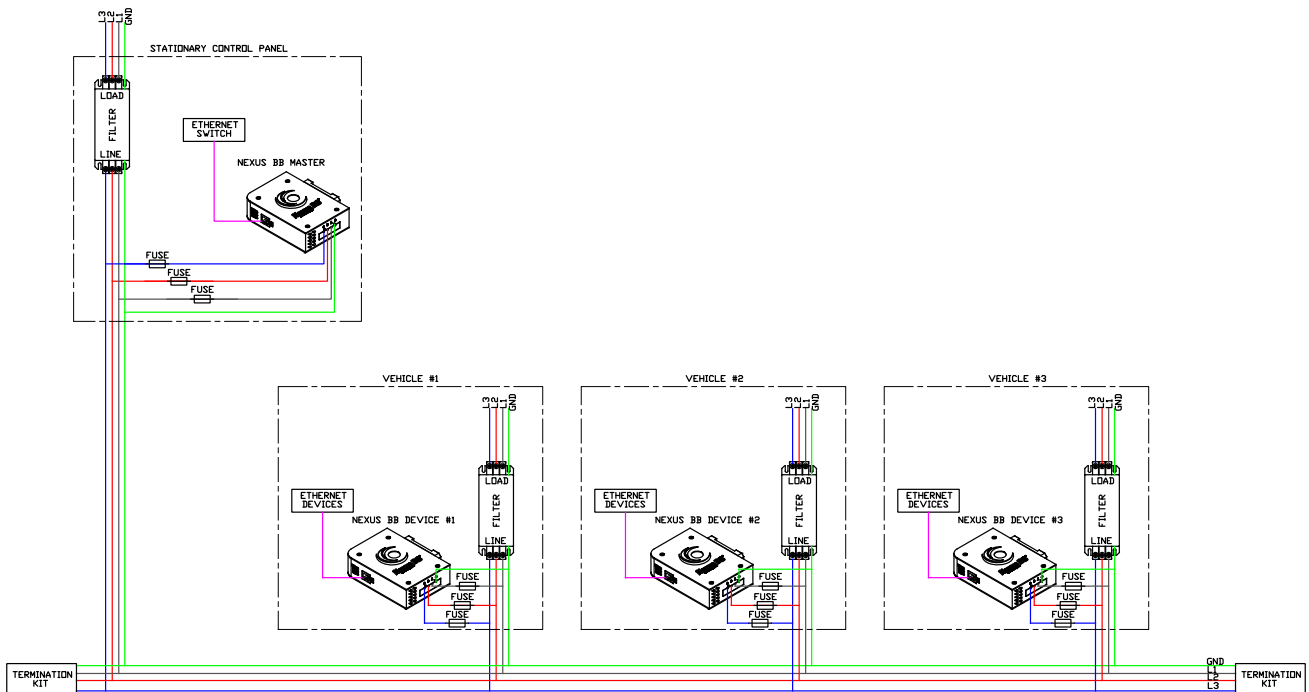

Figure 5-6: Three-Phase AC modem conductor bar (center feed)

# SECTION 5 - SYSTEM WIRING/CONNECTIONS

## 5.2 Connection-AC (Conductor Bar)

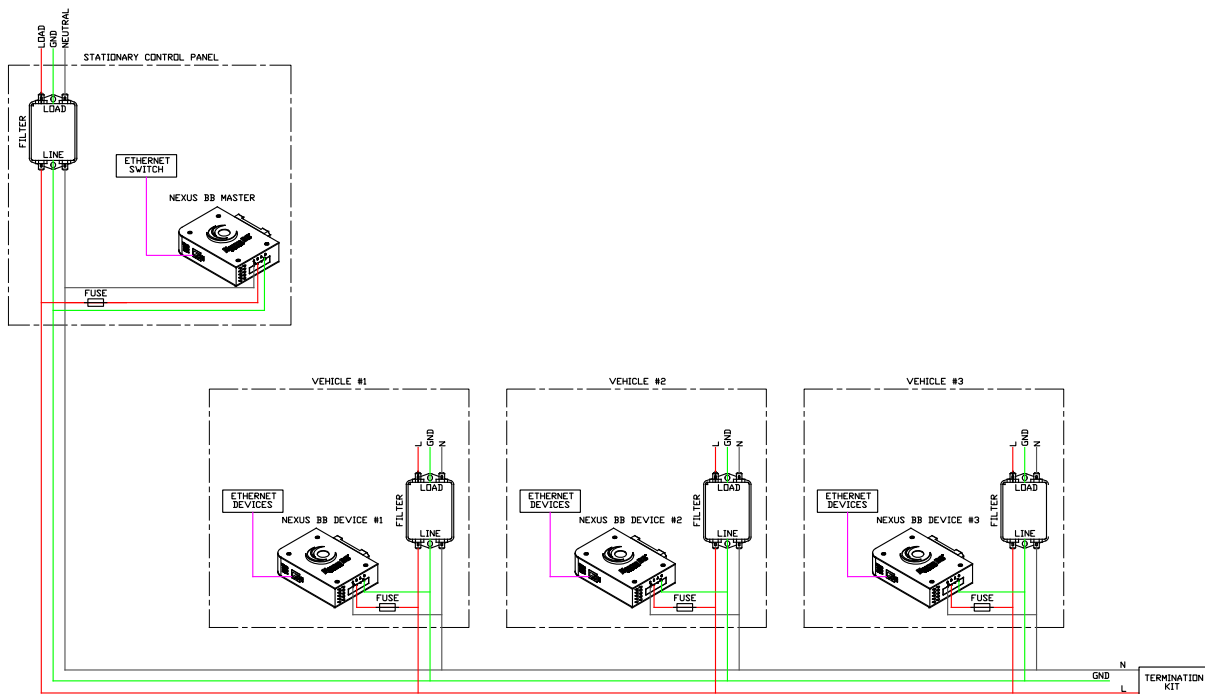

Figure 5-7: Single-Phase AC modem conductor bar (end feed)

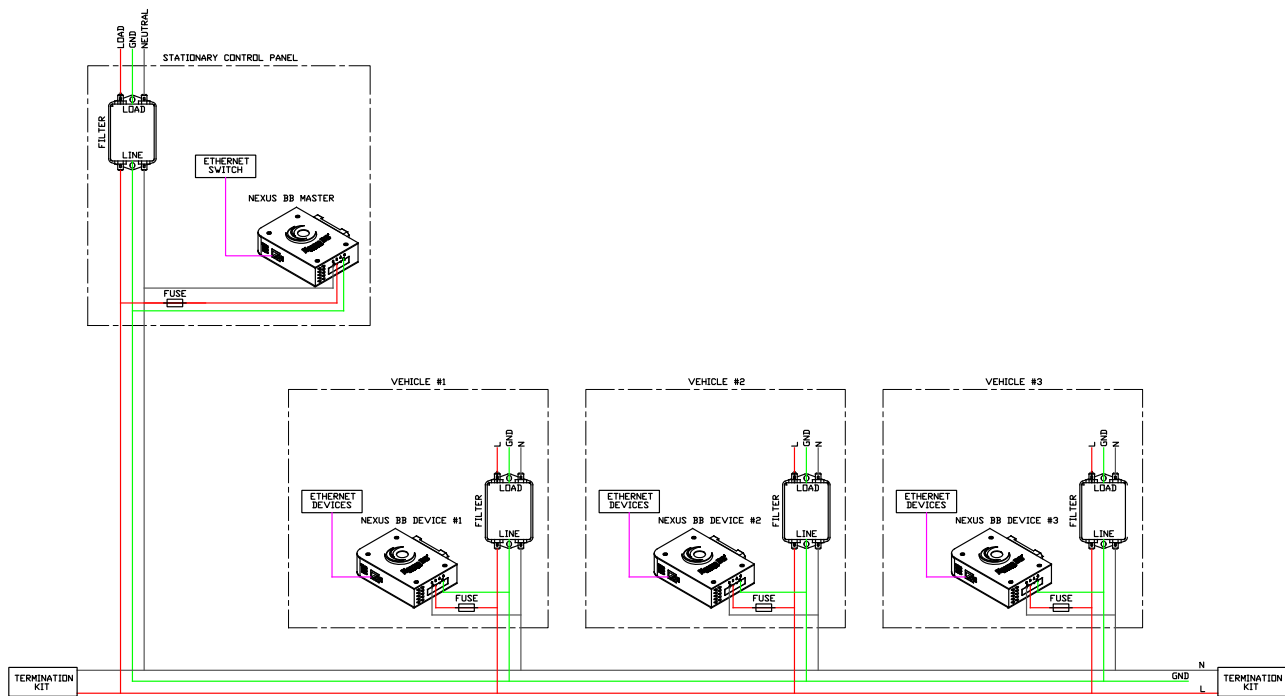

Figure 5-8: Single-Phase AC modem conductor bar (center feed)

# SECTION 5 - SYSTEM WIRING/CONNECTIONS

## 5.3 Connection - DC (Conductor Bar)

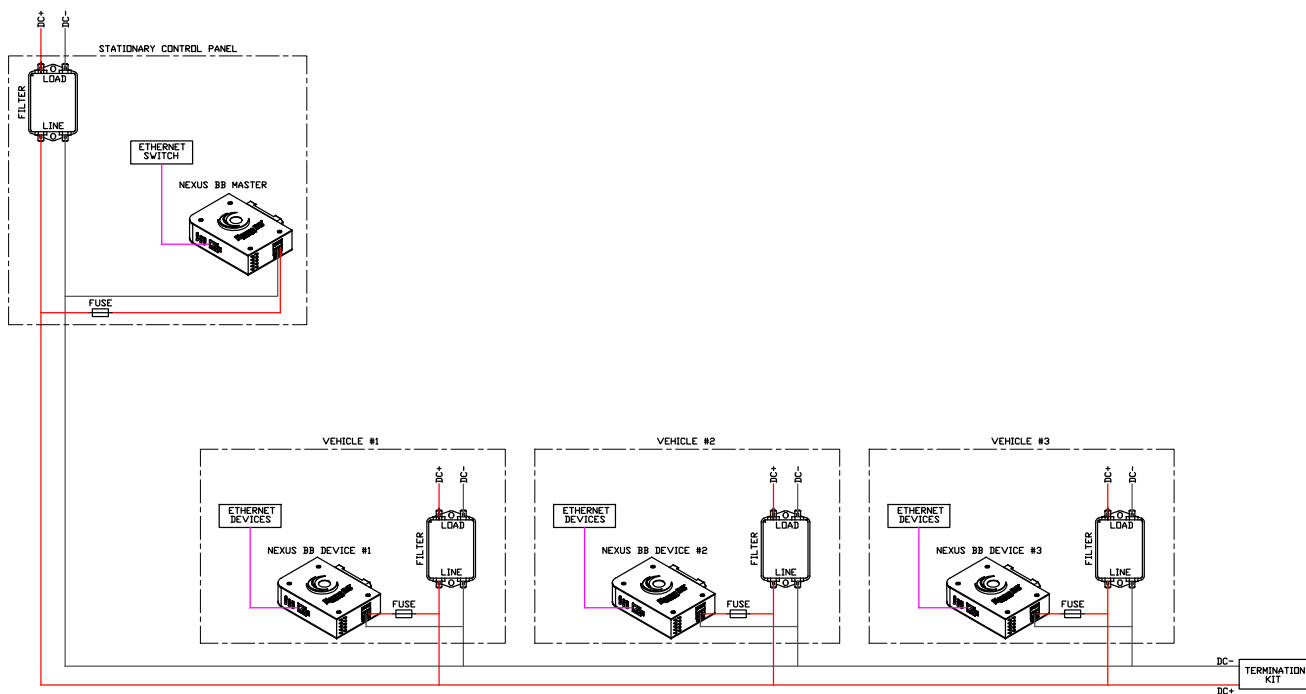

Figure 5-9: DC modem conductor bar (end feed)

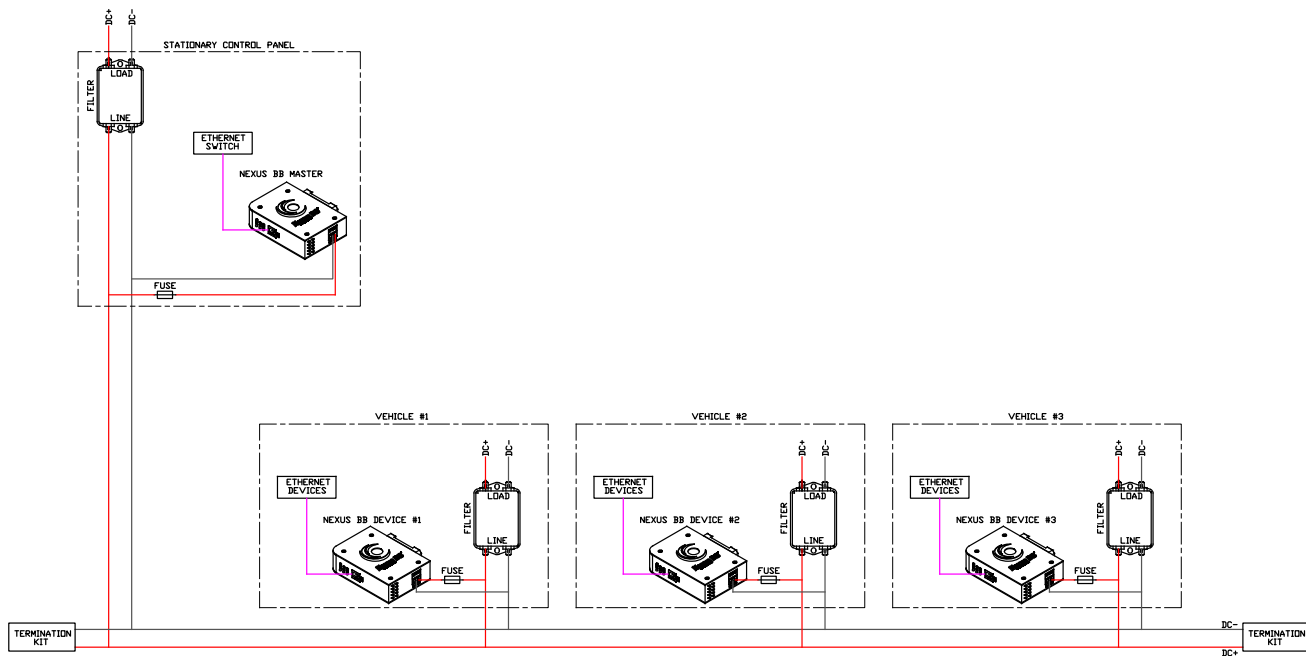

Figure 5-10: DC modem conductor bar (center feed)

## SECTION 6 - INSTALLATION

### 6.0 Required Tools

- #1 flathead screwdriver
- Phillips screwdriver
- Drill
- Related hardware for filter screws, as determined by customer

### 6.1 Application Examples

6.1.1 The Nexus BB can be used in a wide variety of applications. Some of those applications include, but are not limited to:

- Shuttle on rail
- Automated Storage and Retrieval Systems (AS/RS) cranes
- Overhead cranes
- Sorters
- Material Handling

### 6.2 Installation Overview

#### NOTE:

- Both the AC and DC versions of the Nexus BB are able to be mounted on a DIN rail.

6.2.0 The Nexus BB has multiple configurations of how to set it up during the installation process. **Figures 6-1 and 6-2** show the basic setup of installing the unit within an enclosure.

6.2.1 Nexus BB power connector, only supports 12-18AWG (4.0-0.75 mm<sup>2</sup>) wire. To connect Nexus BB directly to power feed cables that are greater than 12AWG (4.0 mm<sup>2</sup>) please use enclosed or open style power distribution blocks. Use 12AWG (4.0 mm<sup>2</sup>) where possible, with the shortest possible length for the highest signal strength.

6.2.2 Each non-grounded wire between the Nexus BB and the filter/power bus should have an in-line fuse installed. For 3-phase system this is the A, B, C wires, for DC systems this is typically the positive wire.

6.2.3 Total wire/cable length including fuses from Nexus BB terminals to power bus must be less than 15" (0.38 m).

6.2.4 Nexus BB does not have a disconnect switch.

6.2.5 Callouts (AC/DC) for **Figures: 6-1 & 6-2**

1. Filter
2. DIN rail-mounted wire terminal
3. Ethernet Switch
4. Nexus BB modem

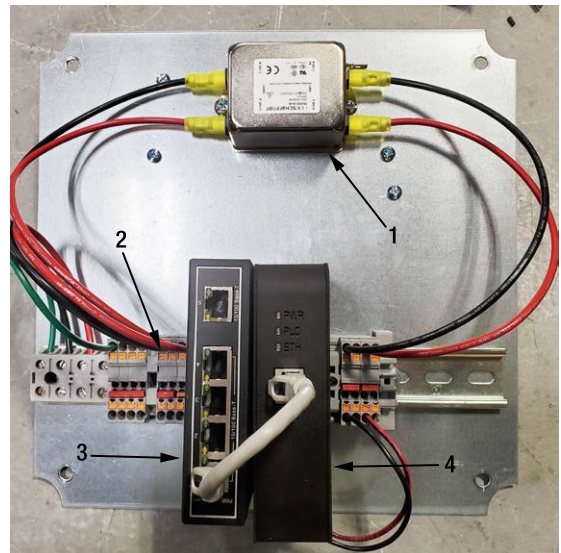

Figure 6-1: Nexus BB Installation (DC modem)

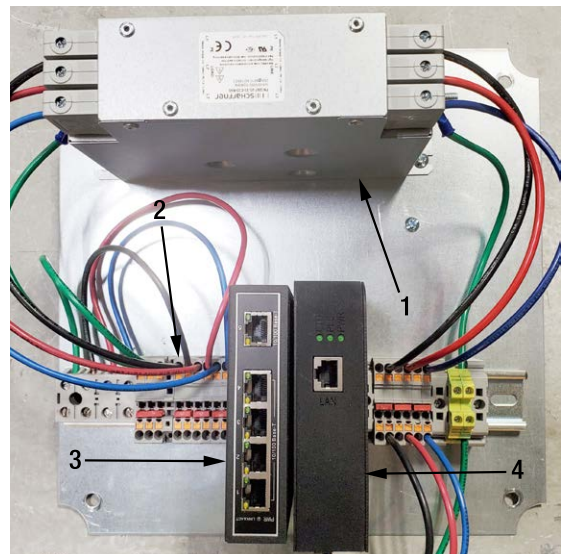

Figure 6-2: Nexus BB Installation (AC modem)

## SECTION 6 - INSTALLATION

### NOTE:

- Single phase systems should be connected to the ground conductor. With DC systems, the ground connection should be used only if there is a continuous connection to ground.

### WARNING

Only trained and authorized operators should wire units. Read the provided manual prior to wiring the units.

- Make sure the system is powered down prior to wiring the units

### 6.3. Electromagnetic Compatibility (EMC)

6.3.0 Electromagnetic Compatibility (EMC) is the ability of electrical equipment and systems to function acceptably in their electromagnetic environment, by limiting the unintentional generation, propagation and reception of electromagnetic energy which may cause unwanted effects such as electromagnetic interference (EMI) or even physical damage in operational equipment. The use of proper wiring is imperative to proper use of the Nexus BB system. Nexus BB system is engineered to be installed next to DC power, suppressed switched loads, filtered AC or DC power which does not also supply other noisy equipment, contractor and solenoid coil circuits.

### 6.4 Noise Coupling

6.4.0 As with other signal or data circuits, Nexus BB is susceptible to noise interference from other sources or other Nexus BB systems.

6.4.1 It's important to take steps to prevent any noise from coupling into the Nexus BB circuit. There are 3 main methods for reducing the noise induced by other high-frequency sources.

1. Shielding of the Nexus BB cables or wires and components. When a shield is installed around the wires, the currents generated by the noise voltages prefer to follow down the lower-impedance path of the shield rather than the signal wires.
2. Separating the Nexus BB cables or wires from the source of noise. The following images describe the best practices for EMC levels of different types of cables and signals.

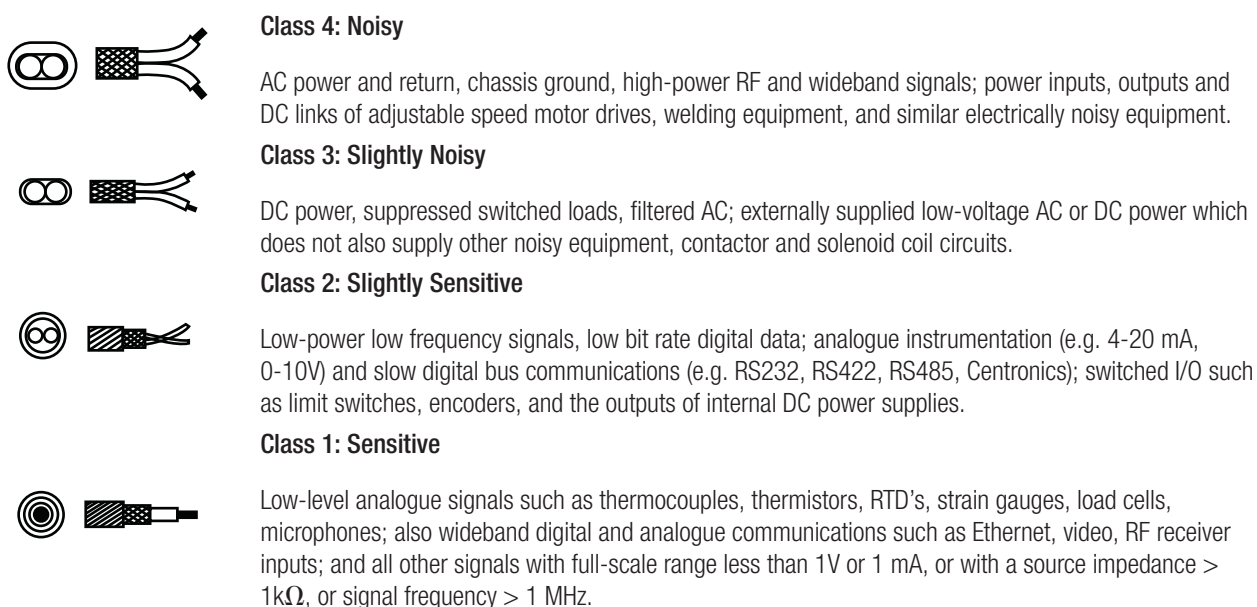

Figure: 6-3

## SECTION 6 - INSTALLATION

### 6.5 Distances between cables with different classes

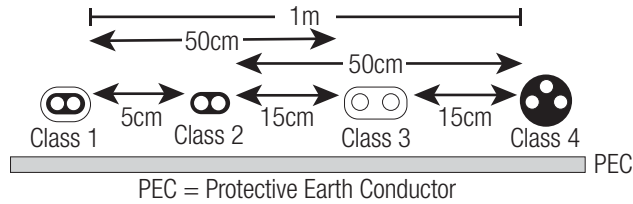

Figure: 6-4

#### NOTE:

- 50cm (20in) should be the minimum separation between Class 4 cables and Slip Rings or Conductor Bars. **Reference Figure: 6-4**
- More than 50cm (20in) of separation allows for increased signal quality.
- 1m (40in) is the minimum separation between different domains in Conductor Bar systems.

#### ATTENTION:

- The distances may be reduced by using appropriate EMC shielding techniques between different classes.

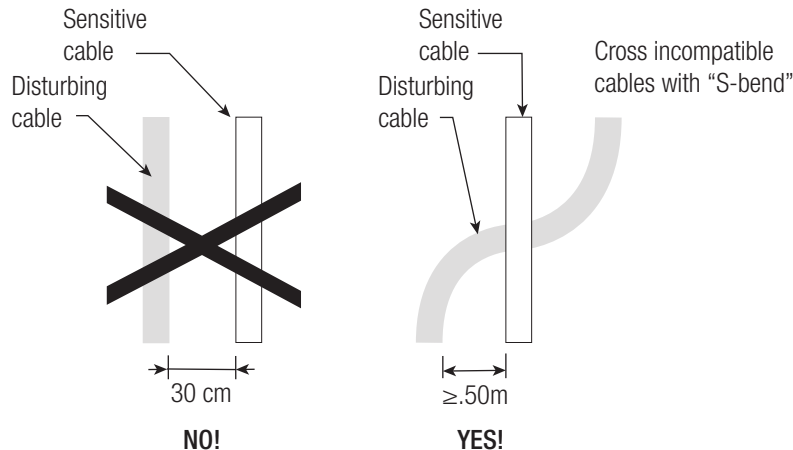

- The medium used to transmit the Nexus BB signal should be considered Class 2.

Figure: 6-5

#### NOTE:

- Cables of different classes should not run parallel to each other whenever possible and should cross each other with "S-bends" as shown in **Figure: 6-5**

6.5.0 Reduce the amplitude of the noise voltage from adjacent "noisy" cables. This could be achieved by the use and proper installation of ferrite rings and/or EMI/EMC filters.

6.5.1 As Nexus BB could be considered a "noisy" power cable itself, it is important to follow this recommendation for other communication or data cables, EMI sensitive equipment, and other Nexus BB systems.

#### Note:

- See EMC/EMI Installation Requirements for detailed layout, grounding, and cable requirements.



## SECTION 6 - INSTALLATION

### 6.6 Installation Recommendations

6.6.0 It is recommended to install the Nexus BB stationary components and mobile components separately in their own enclosure, away from any EMI sources.

6.6.1 When using Nexus BB with the conductor rail as a medium of transport, it is best to place the stationary components near the power source of the conductor rails and the mobile components near the collector shoes. This will reduce signal loss and prevent noise interference by using the least amount of cable possible. If there are other power conductor rails nearby, it is important to take measures to prevent noise interference from those rails. Contact the manufacturer for extra filters to protect against this.

6.6.2 **Figure: 6-6** shows an example of improper or not recommended installation of the Nexus BB components and connecting cables and wires. In this example, the unfiltered cables and the filtered cables run parallel to each other without any separation or shielding. Additionally, the small wires connecting the Nexus BB modem are routed around the filter passing alongside the unfiltered power wires.



**Figure: 6-6 - Improper Installation of System**



**Figure: 6-7 - Proper installation of System**

6.6.3 **Figure: 6-7** shows an example of the recommended way of installing and routing the cables from the Nexus BB modems through the fuses, and to the joining point with the filtered power cables. Wire connections should be made using the shortest wire length possible. Ideally, in this example, the unfiltered power cables (**Black line in Figure: 6-7**) would come in from the top of the enclosure and connect directly to the filter, and the filtered cables (**White lines in Figure: 6-7**) would exit the enclosure straight out of the opposite end of the enclosure. By not crossing or running the Nexus BB wires and Filtered cables parallel or close to the unfiltered ones, the risk of noise coupling is reduced to the minimum possible.

6.5.4 When Nexus BB is used in a Reel, Slip Ring, Festoon, Conductor Rail, etc. applications, and there are more power conductors parallel to the cable, wires, or rail used for Nexus BB signal, steps must be taken to prevent any noise coupling from the other power sources. By following the recommendation listed in **Section 6.4 Noise Coupling**.

## SECTION 6 - INSTALLATION

### 6.7 Multiple Nexus BB Systems (domains)

6.7.0 Currently, Nexus BB can only support up to 6 concurrent domains in one building or one vicinity. Additional domains would require engineering review. *The different Nexus BB domains are fed by the same transformer, then it is considered to be in the same building or vicinity.*

6.7.1 If multiple Nexus BB systems are used in the same building, then it becomes more important to follow all the recommendations listed in the previous sections.

6.7.2 Having the stationary or master components for different domains close to the power feed of the application extends the “electrical” distance between multiple domains and reduces possible crosstalk between domains. The minimum differential attenuation (RSSI) between two domains must be 30db, the greater the differential attenuation between domains the better performance they will have, and vice versa, lower than 30db differential attenuation can cause crosstalk between domains and this will cause communication problems.

#### NOTE:

- This pertains to highly sophisticated installations that encompass multiple systems within a single facility. If you require additional support or guidance, kindly reach out to the manufacturer or the system integrator.

6.7.3 **Figure: 6-8** shows an example of improper or not recommended installation of multiple Nexus BB systems with different domains. In this example all the like components for different domains are installed next to each other inside the cabinet, additionally, all the wires that connect the different components for the same domains are laid parallel to each other without any separation from other domains or shielded. This causes a lot of crosstalk between domains which is seen as EMI by each separate Nexus BB system.

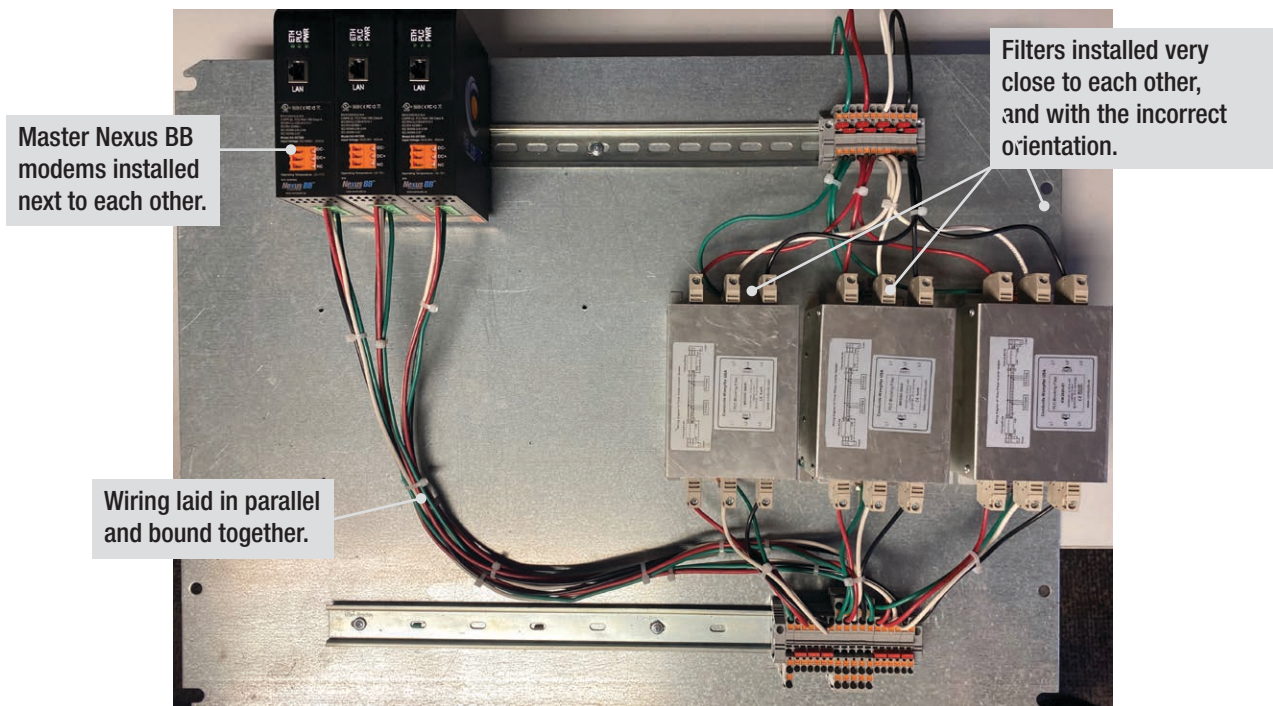

Figure: 6-8

## SECTION 6 - INSTALLATION

### NOTE:

- It is important to keep the filtered side of the power cables that carry the Nexus BB signal (dotted lines in **Figure: 6-9**) as short as possible.

6.7.4 **Figure: 6-9** shows an example of the recommended way of installing the Nexus BB components when there are adjacent Nexus BB domains. The like components (modems, filters, etc.) assigned to different Nexus BB domains are NOT grouped together and instead they are installed inside separate enclosures, and all components including cables and conductor rails are separated far enough to prevent any crosstalk.

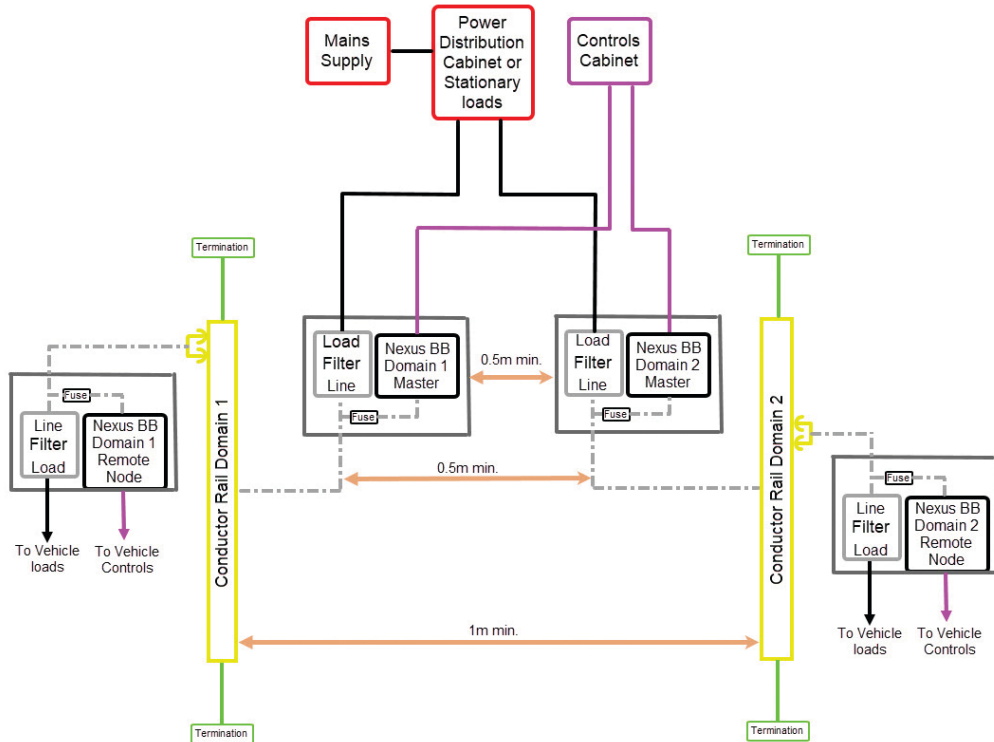

### NOTE:

- It is important to keep the filtered side of the power cables that carry the Nexus BB signal (dotted lines in Figure: 6-8) as short as possible.

Figure: 6-9

## 6.8 EMC/EMI Installation Requirements

6.8.0 The following requirements must be met to ensure proper operation of the Nexus BB system. Failure to meet these requirements may result in inadequate operating margin in the signal-to-noise ratio (SNR) due to electrical noise on the Nexus BB communication path which can cause intermittent communication loss.

### 6.8.1 Layout and Cable Routing

6.8.1.1 Parallel runs of cable between Nexus BB communication power lines and any other noisy cables should be avoided.

- If wires must cross, it should be as close to a 90-degree angle as possible. See **Figure: 6-5**.

## SECTION 6 - INSTALLATION

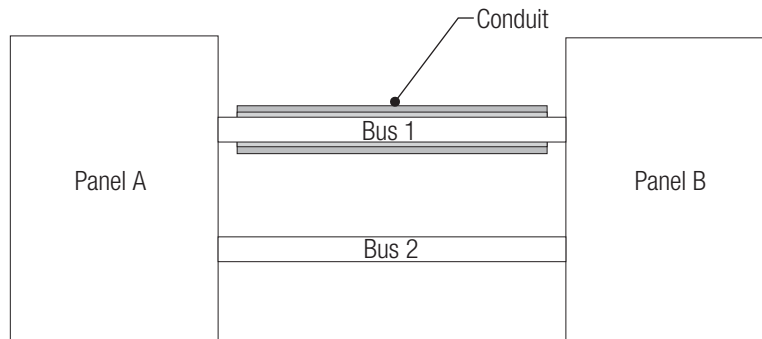

Figure: 6-10

### 6.8.2 Cable runs between panels

6.8.2.1 Do not run unfiltered, un-shielded power cables near Nexus cables on parallel runs.

- Refer to the cable class chart for spacing guidelines.
- If ideal spacing is not possible, 4-6 inches (100-150 mm) is better than no spacing.

6.8.2.2 Cable utilizing a full-coverage metal outer shield can be used to provide effective isolation.

6.8.2.3 Metal conduit around on one or both sets/classes of cables is also effective.

### 6.8.3 Panel layout considerations

6.8.3.1 A separate metal enclosure should be used where possible to house the Nexus BB modem and filter.

6.8.3.2 Wire/cable sets on the load side of the filter should be separated as much as possible from the line side.

- Line-side and load-side cables should never run parallel for any length.

6.8.3.3 The following routing requirements apply if the modem and filter share a cabinet with other power components.

- Output motor cables should never run towards Nexus components if <4 ft (1-2 m) away.
- Sharing enclosure with motor drive is highly discouraged.
- Ferrite cores are required on motor drive input (one per phase). **See Figure: 6-11**

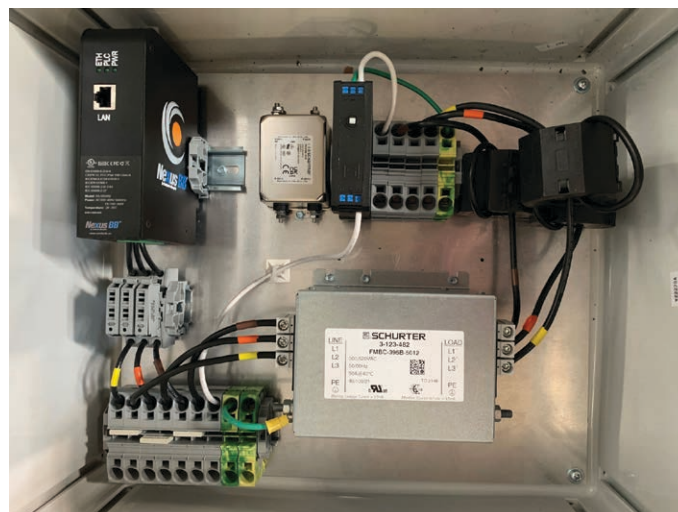

Figure 6-11



## SECTION 6 - INSTALLATION

### 6.8.4 Cable Selection and Grounding

6.8.4.1 Where possible, all cables should be multi-conductor to reduce emissions and coupling effects, including any load cables running near by.

- Shielded cables are highly recommended, especially for motor drive input and output.
- See cable type chart **Figure: 6-3**

6.8.4.2 The following cable shielding requirements/guidelines should be followed.

- Motor drive input and output cables should be shielded if they are within 3ft (1 m) proximity of Nexus BB cables.
- If motor drive input or output cables run parallel to Nexus BB power-line cables, they **MUST** be shielded cable.

6.8.4.3 The following ground and shield requirements should be followed.

- Shielded motor cables should be grounded inside the enclosure containing the motor drive.
  - A low impedance ground is required - clamp type is highly recommended.
  - The other end of the cable should not be grounded unless required by electrical code.
- Metal panel enclosures and back planes should use the shortest possible ground wire to the upstream cable entry point.

## 6.9 Equipment Operation

6.8.0 The units will communicate automatically once they are properly installed and powered on.

6.8.1 There can only be one stationary and up to seven mobile units sharing the same transmission line.

## 6.10 Installation (AC/DC)

### NOTE

- To maximize performance, Conductix-Wampfler recommends the use of powerline filters in both the stationary and mobile control panels where the Nexus BB modems are connected.
- For continuous bar systems with multiple power feeds, it is recommended to put a filter on each feed.
- To optimize performance, ensure the phase units match on both the mobile and stationary modem units and filters. Inputs B/C are used to power the Nexus BB modem. Loss of either phase, on either input, will result in the modem powering off.
- Phases should be matched across all filters and Nexus BB modems to ensure optimal operation.
- When modems are sent programmed with a specific domain name (ex. CxW\_DM85) this will be displayed on a QR code on the modem. You can then match the Domain Master (DM) with the Remote Node(s) (RN). The DM (Domain Number) should match with the DM (Domain Master) at the feed in, and RN(s) (Remote Nodes) on the vehicles.

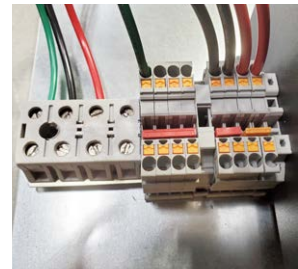

Figure: 6-12

## SECTION 6 - INSTALLATION

### 6.11 Three-Phase Power Connection-Stationary Control Panel

1. Reference Figures: 5-1, 5-5, 5-6
2. Connect from the filter's load side to the main power.
3. Connect all remaining devices/controllers to the filter's load side.
4. Connect from the filter's line side to the Nexus BB modem. Use 12-14 AWG (4.0-2.5 mm<sup>2</sup>) wires and connect as follows: L1 to C; L2 to B; L3 to A; and ground to G.
5. Connect from the filter's line side to the power conductor.
6. Plug one end of an Ethernet cable into the Nexus BB's Ethernet port, and connect the other end to an Ethernet switch/device (we recommend a managed switch for optimal performance).



### 6.12 Three-Phase Power Connection-Mobile Control Panel

1. Reference Figures: 5-1, 5-5, 5-6
2. Connect from the filter's line side to the three-phase power that runs into the mobile control panel via the collectors.
3. Connect the Nexus BB modem to the filter's line side.
4. Connect all remaining devices/controllers to the filter's load side.
5. Plug one end of an Ethernet cable into the Nexus BB's Ethernet port, and connect the other end to an Ethernet switch/device (we recommend a managed switch for optimal performance).



### 6.13 Single-Phase (120 to 250 VAC/100 to 250 VDC) Power Connection-Stationary Control Panel

1. Reference Figures: 5-2, 5-3, 5-7, 5-8
2. Connect from the filter's load side to the main power.
3. Connect all remaining devices/controllers to the filter's load side.
4. Connect from the filter's line side to the Nexus BB modem. Use 12-14 AWG (4.0-2.5 mm<sup>2</sup>) wires and connect as follows: line (DC+) to B; neutral (DC-) to C; and ground to G (only if there is a continuous connection to the Ground.)

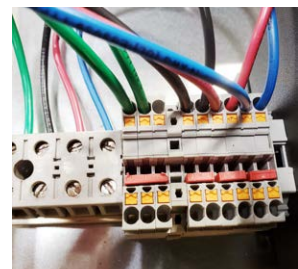
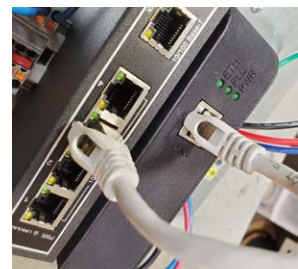

#### NOTE:

- When wiring a three phase filter to a single phase AC or DC system, use L1 to line (DC+) and L2 to Neutral (DC-).
- Connect from the filter's line side to the power conductor.
- Plug one end of an Ethernet cable into the Nexus BB's Ethernet port, and connect the other end to an Ethernet switch/device (we recommend a managed switch for optimal performance).



## SECTION 6 - INSTALLATION

### 6.14 Single-Phase (120 to 250 VAC/100 to 250 VDC) Power Connection-Mobile Control Panel

1. Reference Figures: 5-2, 5-3, 5-7, 5-8
2. Connect from the filter's line side to the single-phase power that runs into the mobile control panel via the panel via the collectors.
3. Connect the Nexus BB modem to the filter's line side.
4. Connect all remaining devices/controllers to the filter's load side.
5. Plug one end of an Ethernet cable into the Nexus BB's Ethernet port, and connect the other end to an Ethernet switch/device. (we recommend a managed switch for optimal performance.)



### 6.15 Single-Phase (24-48 VDC Modem) Power Connection-Stationary Control Panel

1. Reference Figures: 5-4, 5-9, 5-10
2. Connect from the filter's load side to the main power.
3. Connect all remaining devices/controllers to the filter's load side.
4. Connect from the filter's line side to the Nexus BB modem. Use 12-14 AWG (4.0-2.5 mm<sup>2</sup>) wires and connect as follows: DC+ to V+; DC- to V- and leave G unconnected.

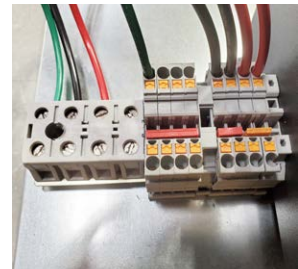

#### NOTE:

- Connect from the filter's line side to the power conductor.
- Plug one end of an Ethernet cable into the Nexus BB's Ethernet port, and connect the other end to an Ethernet switch/device (we recommend a managed switch for optimal performance).



### 6.16 Single-Phase (24-48 VDC Modem) Power Connection-Mobile Control Panel

1. Reference Figures: 5-4, 5-9, 5-10
2. Connect from the filter's line side to the single-phase power that runs into the mobile control panel via the panel via the collectors.
3. Connect the Nexus BB modem to the filter's line side.
4. Connect all remaining devices/controllers to the filter's load side.
5. Plug one end of an Ethernet cable into the Nexus BB's Ethernet port, and connect the other end to an Ethernet switch/device. (we recommend a managed switch for optimal performance).

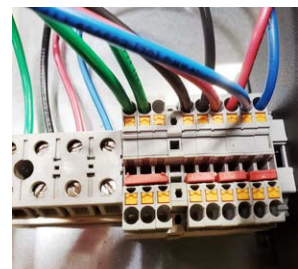
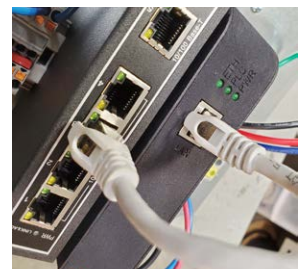

## SECTION 6 - INSTALLATION

### 6.17 Termination Wiring

6.16.0 Terminations are only used on conductor bar systems. They are wired into an end power feed. A end feed system requires one termination at the end opposite of the power feed. Center feed systems requires termination resistors on both ends of the conductor bar.

6.16.1 The four 12-18 AWG (4.0-0.75 mm<sup>2</sup>) wires are **black**, **red**, **white**, and **green**. For AC applications, **black** connects to L1, **white** connects to L2, **red** connects to L3, and **green** connects to ground. For DC and single-phase applications, black connects to Line or DC+, and white connects to Neutral or DC-.

#### NOTE:

- The provided cable should not be changed or the length of the cable increased.

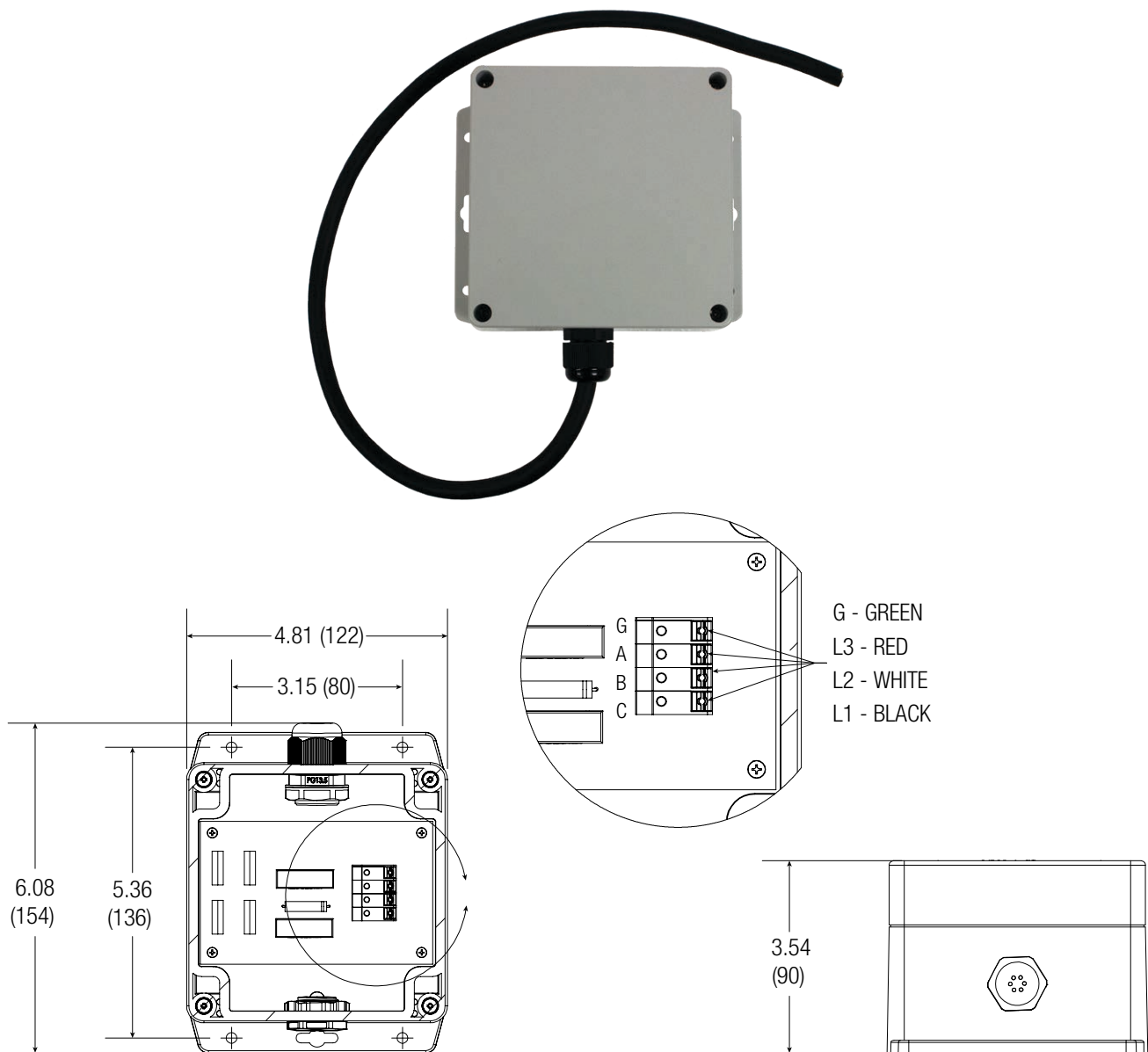

Figure 6-13: Termination Box with cover removed to show wiring information.



## SECTION 6 - INSTALLATION

### 6.18 Clearance For Cooling/Wiring

6.17.0 The Nexus BB device is designed for natural convection cooling. For proper cooling, please provide a clearance of at least 25 mm both above and below the devices, as well as 25 mm of depth between the front of the module and inside the enclosure.

6.17.1 When planning the layout, allow enough clearance for the wiring and communications cable connections.

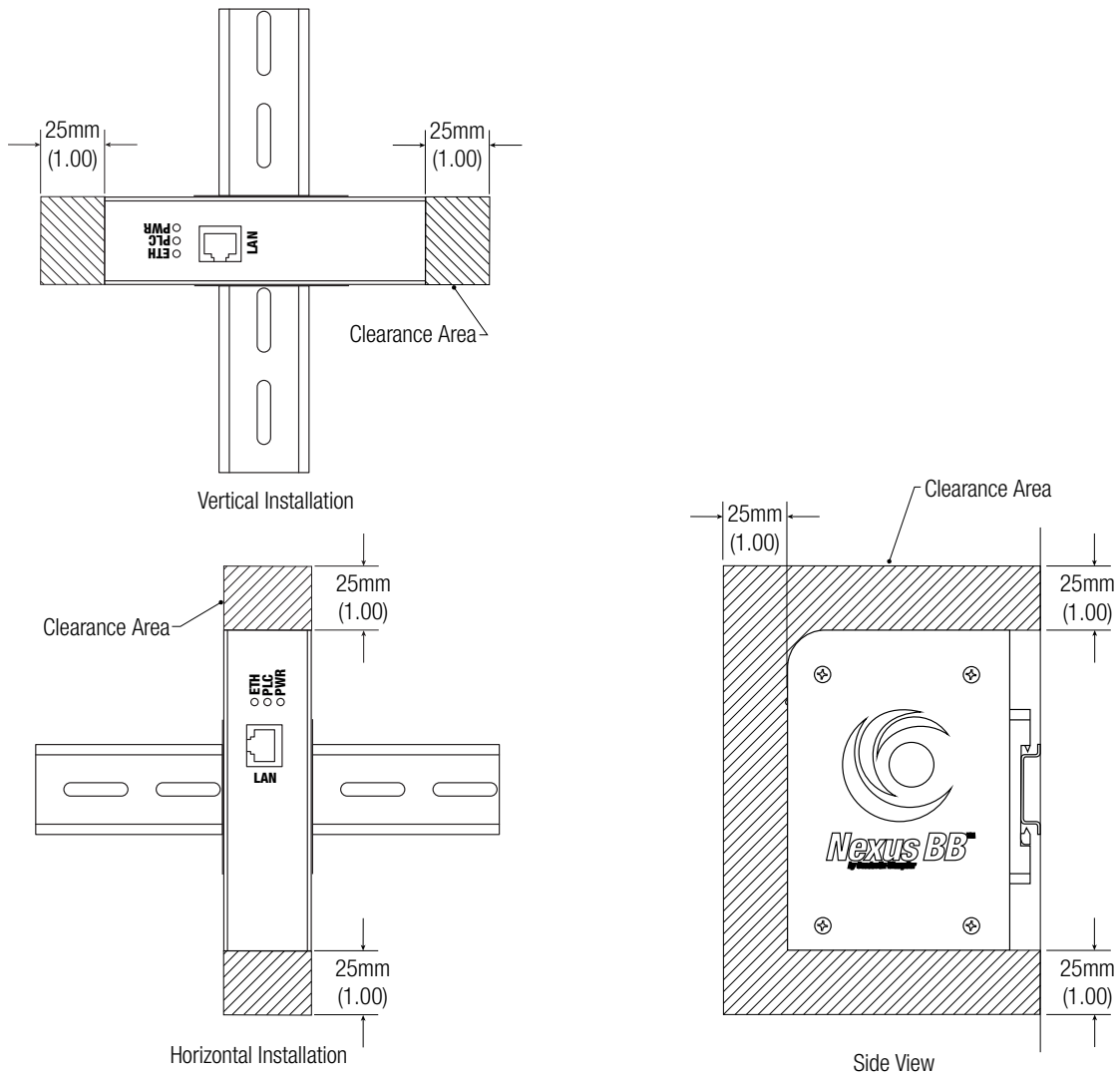

Figure 6-14: Clearance dimensions in mm (inches)

## SECTION 7 - MODEM SPECIFICATIONS

### 7.0 Maintenance Warnings

#### **WARNING**

Modification of the equipment may cause excessive wear, and **will void the warranty**. Contact the manufacturer regarding changes or modifications of equipment that could affect product reliability or safety.

- **United States: (800) 521-4888**
- **Canada: (800) 667-2487**

### 7.1 System Specifications

7.1.0 This device complies with part 15 of the FCC rules. Operation is subject to the following two conditions. (1) This device may not cause harmful interference. (2) This device must accept any interference received, including interference that may cause undesired operation.

Modem Specifications	Low Voltage DC	Single & Three Phase Power	
Part Number	XA-NBB-C-I-AA	XA-NBB-B-I-AA	XA-NBB-A-I-AA
<b>Electrical</b>			
Nominal Voltage (UL Rating)	48 VDC	600 VAC	480 VAC
Lower limit	18 VDC	150 VAC / 210 VDC	100 VAC / 150 VDC
Upper limit	60 VDC	600 VAC / 600 VDC	480 VAC / 300 VDC
Max. Current consumption	100 mA	100 mA	150 mA
Protocol	IEEE802.3, IEEE802.3x, IEEE802.3u, G.hn		
Transfer band	2 - 50Mhz SISO/MIMO		
Security	128-AES		
<b>Ethernet Interface</b>			
Interface type	Ethernet	Ethernet	Ethernet
Number of ports	1	1	1
Automatic detection of transmission rate	Yes	Yes	Yes
Auto negotiation	Yes	Yes	Yes
Auto crossing	Yes	Yes	Yes
<b>Industrial Ethernet Protocols Supported</b>			
Ethernet/IP	Yes	Yes	Yes
EtherCAT	Yes	Yes	Yes
PROFINET	Yes	Yes	Yes
TCP/IP	Yes	Yes	Yes
UDP	Yes	Yes	Yes
Modbus TCP/IP	Yes	Yes	Yes
Transmission Rate	175 Mbps	350 Mbps	350 Mbps
Recommended PLC Refresh Rate	64 ms	64 ms	64 ms

## SECTION 7 - MODEM SPECIFICATIONS

Modem Specifications	Low Voltage DC	Single & Three Phase Power	
Part Number	XA-NBB-C-I-AA	XA-NBB-B-I-AA	XA-NBB-A-I-AA
<b>EMC</b>			
Interference immunity against discharge or static electricity acc. to IEC 61000-4-2	Yes	Yes	Yes
Interference immunity to cable-borne interference acc. to IEC 61000-4-4	Yes	Yes	Yes
Interference immunity against voltage surge acc. to IEC 61000-4-5	Yes	Yes	Yes
Interference immunity against conducted variable disturbance induced by high-frequency fields acc. to IEC 61000-4-6	Yes	Yes	Yes
Emission of radio interference acc. to EN 55 011	Yes	Yes	Yes
<b>Degree and Class of Protection</b>			
IP degree of protection	IP20	IP20	IP20
<b>Standards, approvals certificates</b>			
CE Mark	Yes	Yes	Yes
UL Approval	Yes	Yes	Yes
cULus	Yes	Yes	Yes

## SECTION 7 - MODEM SPECIFICATIONS

Ambient conditions	
Ambient temperature during operation	-20° C to +70° C  *XA-NBB-A-I-AA is UL rated for -20° C to +60° C  **XA-NBB-B-I-AA is UL Rated for -20° C to +50° C
Ambient temperature during storage	-40° C to +70° C
Humidity	0-95% non-condensing
Air pressure during operation	795 to 1080 hPa
Air pressure during storage	660 to 1080 hPa
Altitude during operation relating to sea level	-1000 m to 2000 m
Vibrations	
Vibration resistance during operation according to IEC 60068-2-6	2 g (m/s <sup>2</sup> ) wall mounting, 1 g (m/s <sup>2</sup> ) DIN rail
Operation, tested according to IEC 60068-2-6	Yes
Shock Testing	
Tested according to IEC 60068-2-27	Yes
Dimensions - XA-NBB-C-I-AA	
Width	125 mm
Height	95 mm
Depth	35 mm
Weight	0.3 kg
Dimensions - XA-NBB-A-I-AA & XA-NBB-B-I-AA	
Width	135 mm
Height	104.7 mm
Depth	41.4 mm
Weight	0.3 kg

## SECTION 8 - TROUBLESHOOTING

Problem	Possible Cause
(1) Power Indicator Light is off	Device has no power <ul style="list-style-type: none"> <li>• Check and make sure power wire is properly connected</li> <li>• Ensure proper power source is being used</li> </ul>
(2) PLC indicator light is OFF	Ensure both devices are powered on. Ensure the devices are connected to the filters on the line side, per the diagram ( <b>refer to applicable figure in Section 5</b> ) Ensure a continuous power-line connection between the stationary and mobile modems. Ensure matching of Nexus BB modems to the correct domain. ( <b>Refer to Section 6.10</b> ).
(3) Network indicator light is OFF	Ensure the Ethernet cable is properly connected between the modems and the switches. Ensure the Ethernet cable does not have any kinks, abrasions or cuts.
(4) Ethernet port does not securely hold cable	Remove cable from port, insert cable back into the port until there is a click. Replace cable or connector as needed.

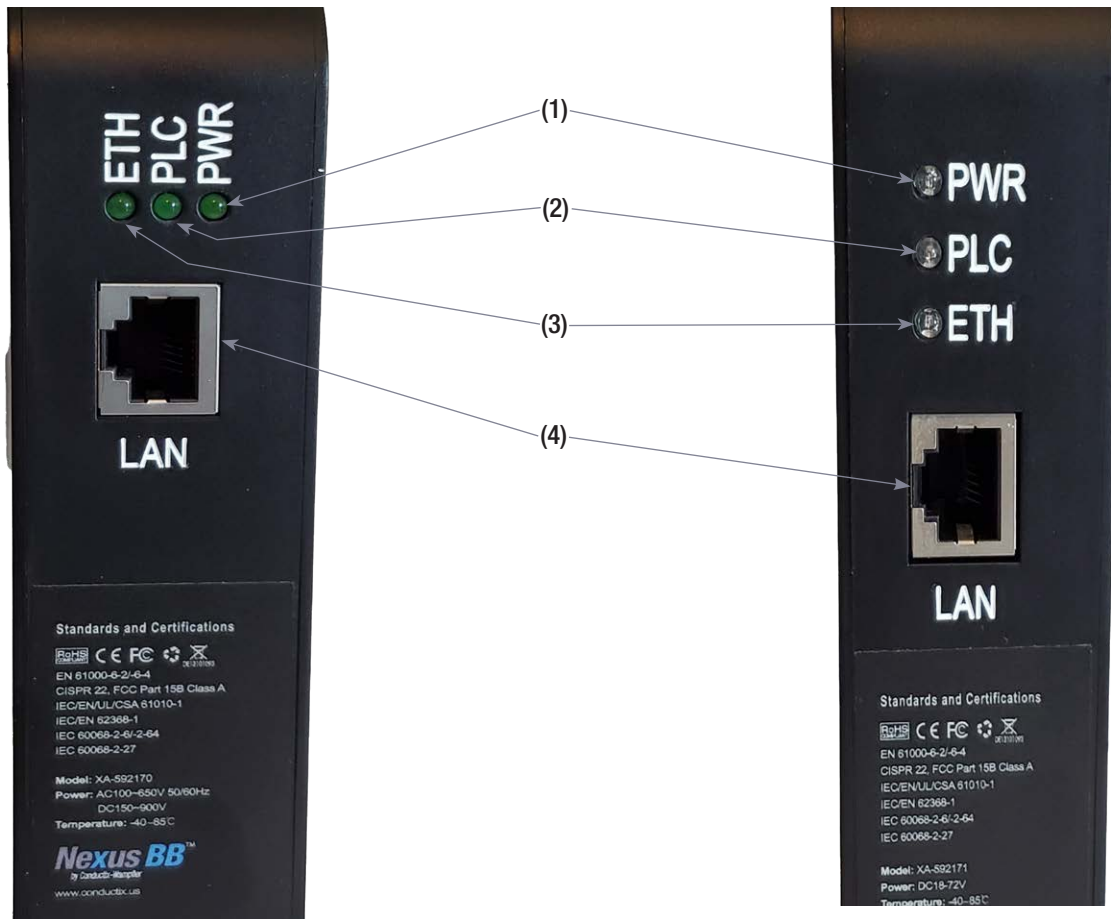

# www.conductix.us

## USA / LATIN AMERICA

10102 F Street  
Omaha, NE 68127

Customer Support  
Phone +1-800-521-4888

Phone +1-402-339-9300  
Fax +1-402-339-9627

info.us@conductix.com  
latinamerica@conductix.com

## CANADA

1435 Norjohn Court  
Unit 5  
Burlington, ON L7L 0E6

Customer Support  
Phone +1-800-667-2487

Phone +1-450-565-9900  
Fax +1-450-951-8591

info.ca@conductix.com

## MÉXICO

Calle Treviño 983-C  
Zona Centro  
Apodaca, NL México 66600

Customer Support  
Phone (+52 81) 1090 9519  
(+52 81) 1090 9025  
(+52 81) 1090 9013

Fax (+52 81) 1090 9014

info.mx@conductix.com

## BRAZIL

Rua Dois, 493  
Itu, São Paulo, Brasil  
CEP: 13312-820

Customer Support  
Phone (+55 11) 4813 7330

Fax (+55 11) 4813 7330

info.br@conductix.com

Contact us for our Global Sales Offices

